

Mobility | Security | Passion

Mobility technologies to drive.
Security technologies to protect.
Passion for both.

CMD 2019

Armin Papperger
Unterlüß | 20 November 2019



**We live in a
disruptive world**



Mobility

Increasing **complexity** with
diminishing transparency

Rapid transition and
increasing interconnectedness



Security

Greater **uncertainty** and
a rise in the need for security

Increasing **environmental risks** and
new conflict scenarios



What kind of needs do people have?
What threatens people?



Old threats...
undergo a **renaissance**



New threats...
emerge



Accelerated
Globalization

Attack on
trade routes

Scarcity of
raw materials

Piracy

Regional
Conflicts

Hybrid
Warfare

Non-
cooperative
Drones

Russian
Aggression

Old threats...
undergo a **renaissance**

New threats...
emerge

Vulnerable
mission
logistic

Failure of
Critical
Infrastructure

Nuclear
Proliferation

Expansionism

Organized
Crime

Terrorism

Climate Change

Transmission
Impairments in
Communication

Cyber-
attacks



**Rheinmetal technologies as an
answer to current threats and challenges**

Expand activities through the

CAPITALIZATION OF ABILITIES



Fields of technology,

PLATFORMS AND TECHNOLOGY PROJECTS

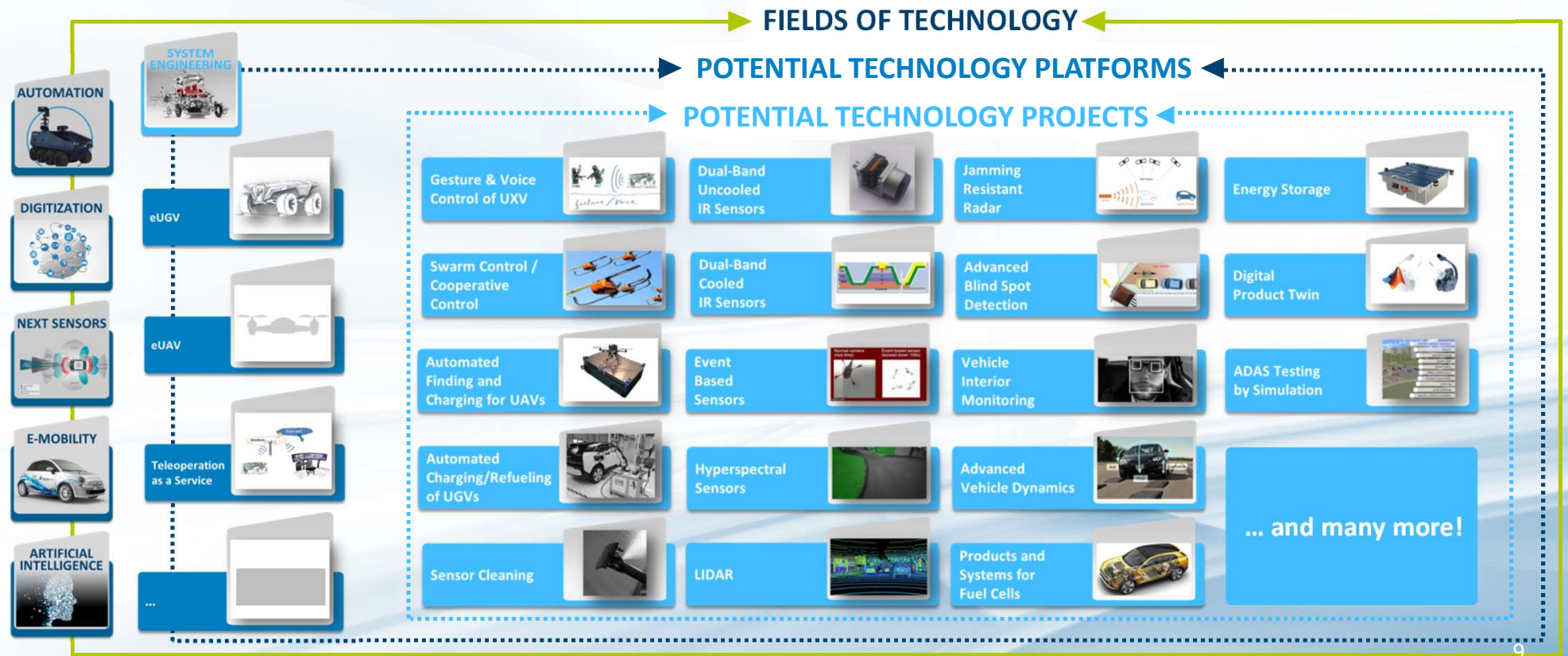

Fields of technology

TECHNOLOGY PROJECTS (SELECTION)

Dual-Band
Uncooled
IR Sensors



Swarm Control /
Cooperative
Control



Digital
Product Twin



Hyperspectral
Sensors



Advanced
Vehicle Dynamics



Sensor Cleaning



Products and
Systems for
Fuel Cells



New Organizational units

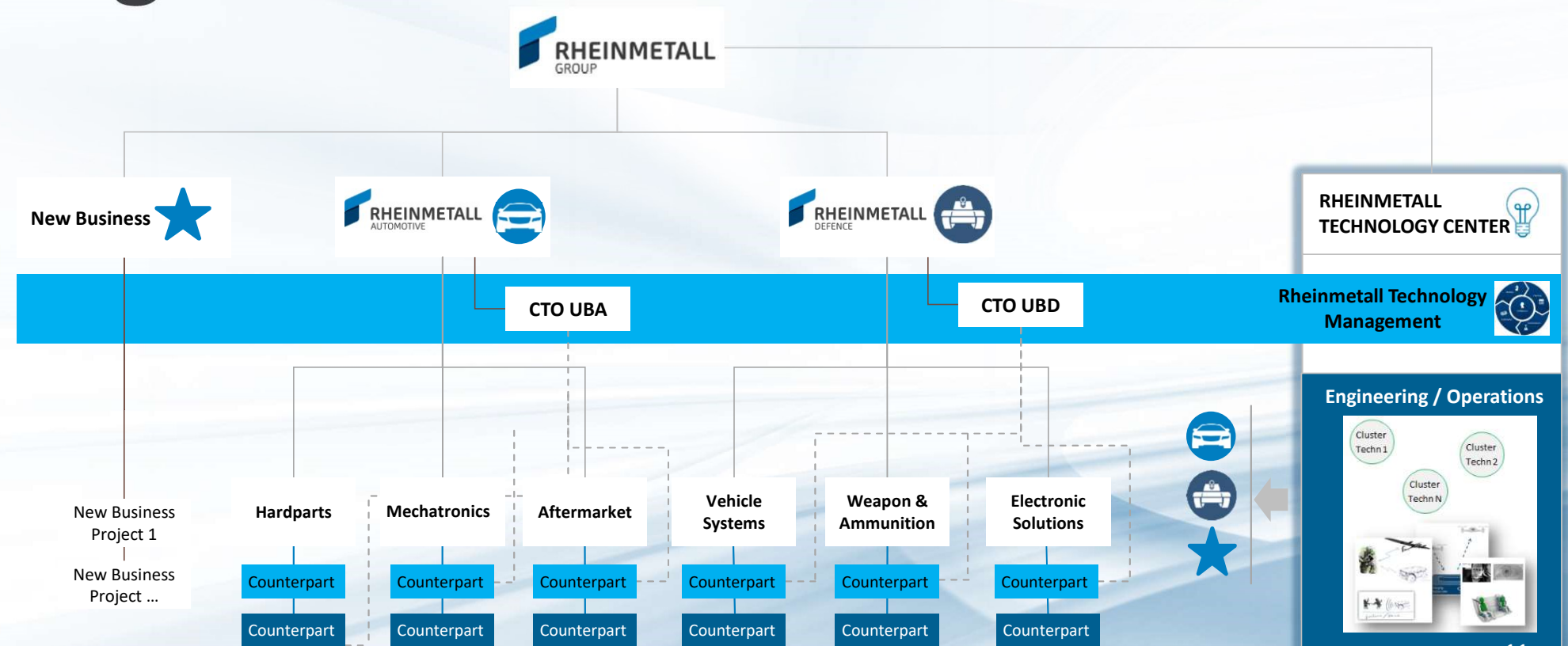



Rheinmetal Products as an answer to current threats and challenges

Accelerated
Globalization

Attack on
trade roots

Scarcity of
raw materials

Piracy

Regional
Conflicts

Hybrid
Warfare

Non-
cooperative
Drones

Russian
Aggression

Old threats...
undergo a **renaissance**

New threats...
emerge

Vulnerable
mission
logistic

Failure of
Critical
Infrastructure

Nuclear
Proliferation

Expansionism

Organized
Crime

Terrorism

Climate Change

Transmission
Impairments in
Communication

Cyber-
attacks



CRITICAL INFRASTRUCTURE



Accelerated
Globalization

Attack on
trade roots

Scarcity of
raw materials

Piracy

Regional
Conflicts

Hybrid
Warfare

Non-
cooperative
Drones

Russian
Aggression

Old threats...
undergo a **renaissance**

New threats...
emerge

Vulnerable
mission
logistic

Failure of
Critical
Infrastructure

Nuclear
Proliferation

Expansionism

Organized
Crime

Terrorism

Climate Change

Transmission
Impairments in
Communication

Cyber-
attacks

DRONE DEFENCE



DRONE DEFENCE

Gatwick Incident December 2018

- Drone attack disrupted Gatwick for 3 days in Dec. 2018
- Caused major disruption, affecting approximately 140,000 passengers and 1,000 flights.
- Total estimated cost for airport and airlines **€30m – €35m**



Rheinmetall Drone Defence System as an effective solution

(Radar, EO-Sensor, Sykmaster, Tracking Software, Jammer, Drone)

Accelerated
Globalization

Attack on
trade roots

Scarcity of
raw materials

Piracy

Regional
Conflicts

Hybrid
Warfare

Non-
cooperative
Drones

Russian
Aggression

Old threats...
undergo a **renaissance**

New threats...
emerge

Vulnerable
mission
logistic

Failure of
Critical
Infrastructure

Nuclear
Proliferation

Expansionism

Organized
Crime

Terrorism

Climate Change

Transmission
Impairments in
Communication

Cyber-
attacks



**WEAPONIZED UNMANNED
GROUND VEHICLE**

Rheinmetall

MISSION MASTER

Winner of ELROB* – Award 2018



- Extremely versatile
- Fully modular
- Adaptable to various mission scenarios
- Easily installable mission modules

*European Land Robot Trail



PROTECTION



CARGO



SURVEILLANCE



RESCUE



COMM RELAY



CBRN DETECTION



FIREFIGHTING

Accelerated
Globalization

Attack on
trade roots

Scarcity of
raw materials

Piracy

Regional
Conflicts

Hybrid
Warfare

Non-
cooperative
Drones

Russian
Aggression

Old threats...
undergo a **renaissance**

New threats...
emerge

Failure of
Critical
Infrastructure

Expansionism

Terrorism

Transmission
Impairments in
Communication

Vulnerable
mission
logistic

Nuclear
Proliferation

Organized
Crime

Climate Change

Cyber-
attacks

MAIN GROUND COMBAT SYSTEM



NEXT GENERATION OF MBTS

MAIN GROUND COMBAT SYSTEM

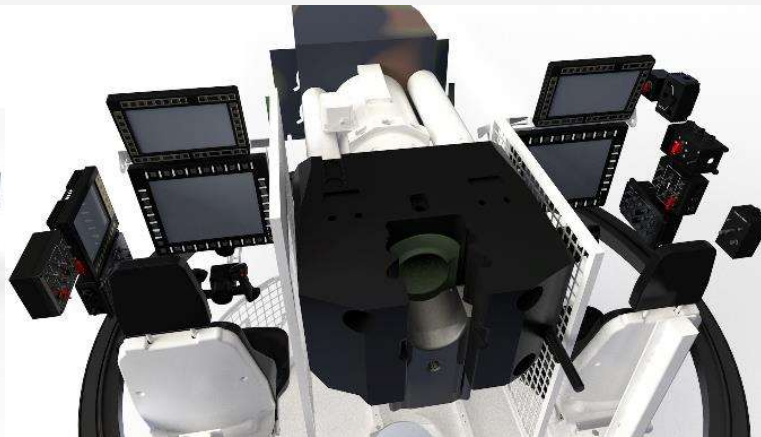

Digital turret



130mm cannon

NEW PRODUCT

NEXT GENERATION OF MBT



130mm
Cannon and ammunition

LEOPARD 2 PLATFORM

POTENTIALS



Accelerated
Globalization

Attack on
trade roots

Scarcity of
raw materials

Piracy

Regional
Conflicts

Hybrid
Warfare

Non-
cooperative
Drones

Russian
Aggression

Old threats...
undergo a **renaissance**

New threats...
emerge

Failure of
Critical
Infrastructure

Expansionism

Terrorism

Transmission
Impairments in
Communication

Vulnerable
mission
logistic

Nuclear
Proliferation

Organized
Crime

Climate Change

Cyber-
attacks

LOAD HANDLING SYSTEM POTENTIALS



TENDERED BUSINESS

- **4.000 Trucks** Germany, thereof **2.000 protected**

FURTHER POTENTIALS

- **Military trucks** eg. UK, Australia and Scandinavia
- **Exploration** of civil market applications **ongoing**
- German market accounts for approx. **60.000 civil hooklift loaders**

Accelerated
Globalization

Attack on
trade roots

Scarcity of
raw materials

Piracy

Regional
Conflicts

Hybrid
Warfare

Non-
cooperative
Drones

Russian
Aggression

Old threats...
undergo a **renaissance**

New threats...
emerge

Vulnerable
mission
logistic

Failure of
Critical
Infrastructure

Nuclear
Proliferation

Expansionism

Organized
Crime

Terrorism

Climate Change

Transmission
Impairments in
Communication

Cyber-
attacks



ELECTRIFICATION

EMISSION

EFFICIENCY

NEW PRODUCTS, CLUSTER TECHNOLOGIES, SERVICES,...

ELECTRIFICATION

at Rheinmetall Automotive



ELECTRIFICATION

Peripheral system and components

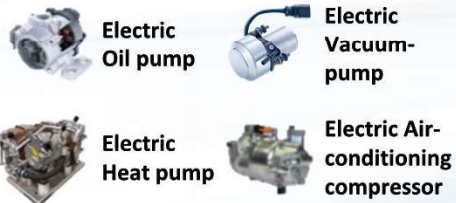

CAR

(HV) 400V^{PLUS}
50-125KW



FIRST-/LAST-MILE

48V
15-20KW



MICRO E-DRIVE SYSTEM

48V
0,25-0,7KW



MARKET SUCCESS

Rheinmetall products for NEV



E-Tron

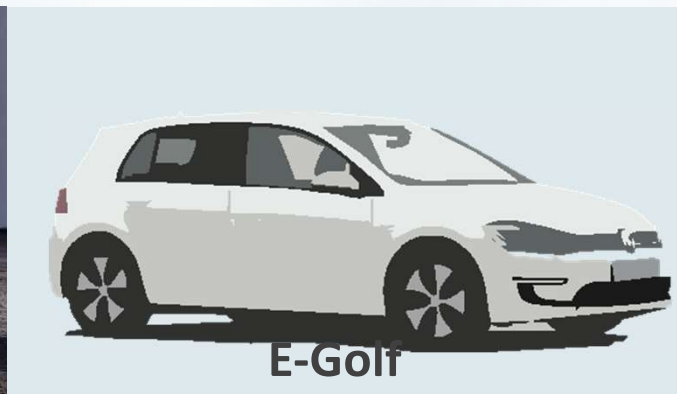

E-Golf

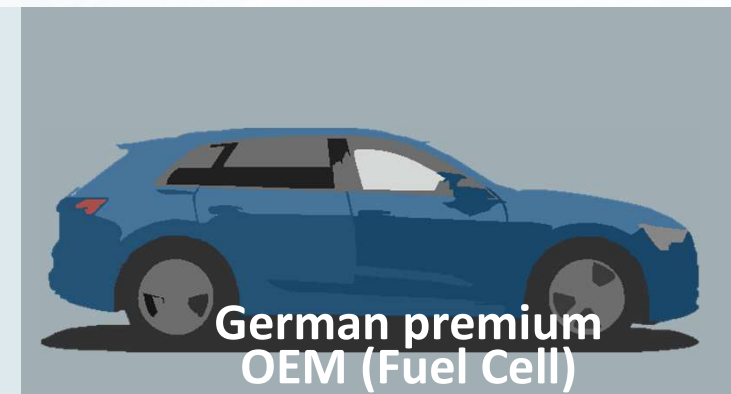

**German premium
OEM (Fuel Cell)**



**BATTERY
BOXES**



**E-ENGINE
HOUSING**



**ELECTRIC
CATHODE
VALVE**



**FUEL CELL
CONTROL
VALVE**

Illustrative examples

Micro E-Drive System

E-BIKE



Micro E-Drive System E-BIKE MARKET

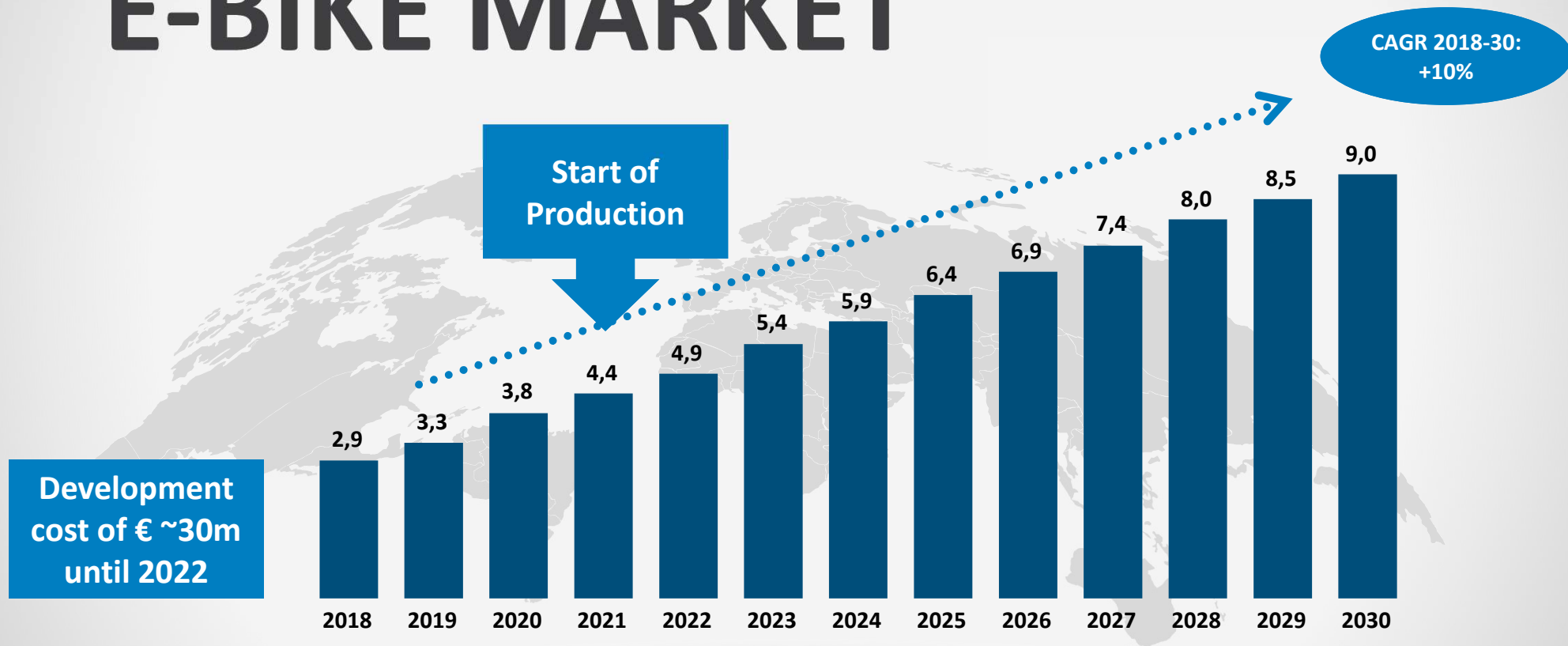

European e-Bike sales forecast [mUnits]

Accelerated
Globalization

Attack on
trade roots

Scarcity of
raw materials

Piracy

Regional
Conflicts

Hybrid
Warfare

Non-
cooperative
Drones

Russian
Aggression

Old threats...
undergo a **renaissance**

New threats...
emerge

Failure of
Critical
Infrastructure

Expansionism

Terrorism

Transmission
Impairments in
Communication

Vulnerable
mission
logistic

Nuclear
Proliferation

Organized
Crime

Climate Change

Cyber-
attacks

The background features a blue gradient with a white hexagonal grid pattern on the left and a white circuit board pattern on the right. A large, semi-transparent blue box with rounded corners is centered horizontally, containing the main text. To the left of the box, a 5G communication tower is visible against a bright sky, with a large satellite dish antenna mounted on it.

5G-Data safety

Major contract for Rheinmetall in China

Accelerated
Globalization

Attack on
trade roots

Scarcity of
raw materials

Piracy

Regional
Conflicts

Hybrid
Warfare

Non-
cooperative
Drones

Russian
Aggression

Old threats...
undergo a **renaissance**

New threats...
emerge

Failure of
Critical
Infrastructure

Expansionism

Terrorism

Transmission
Impairments in
Communication

Vulnerable
mission
logistic

Nuclear
Proliferation

Organized
Crime

Climate Change

Cyber-
attacks

Strategic approach

Establishing attractive “HOME MARKETS”

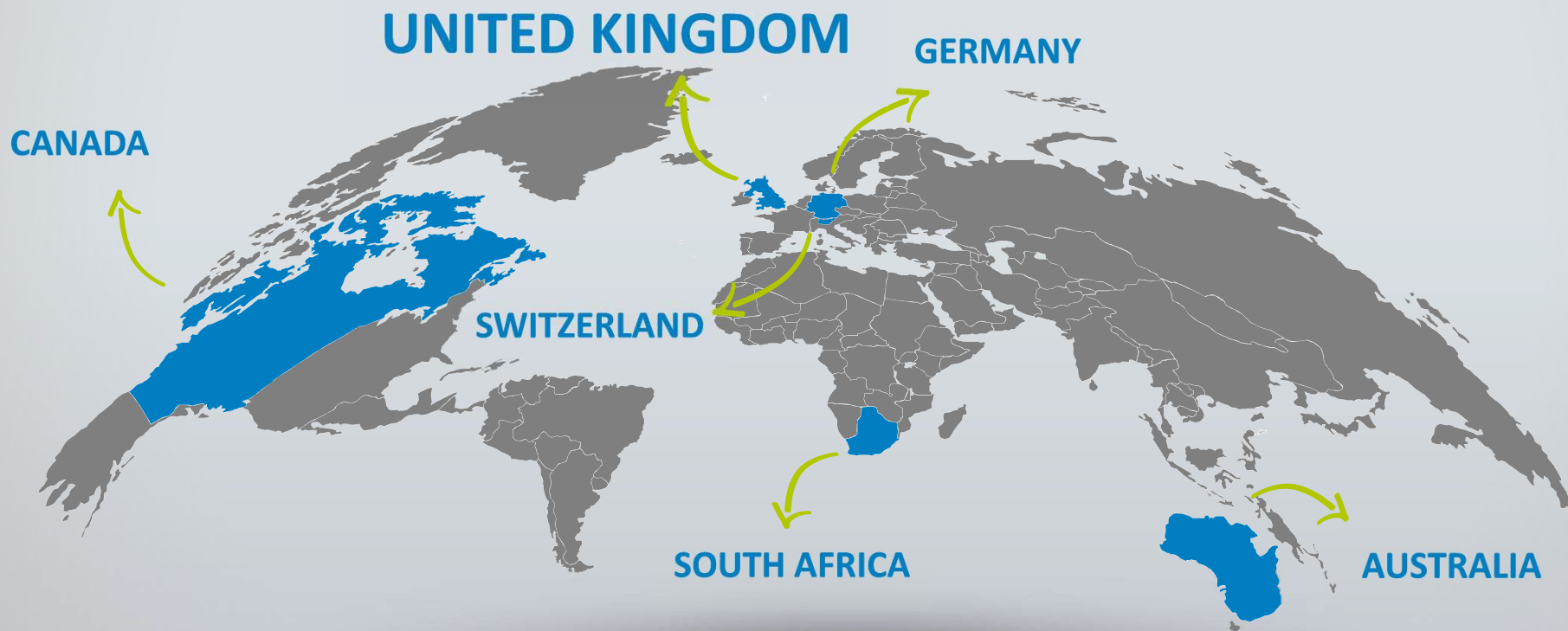

Home Market UK

Joint venture – Strengthening the position in UK



Rheinmetall Defence / Rheinmetall MAN Military Vehicles

- Rheinmetall Defence UK

Rheinmetall Technical Publications

- Technical documentation for major OEMs



Rheinmetall BAE Systems Land

- Military vehicles and related products (development, production and service)



Mechadyne Automotive

- Advanced valve train technology



RFEL

- Signal and video editing solutions for government, defence, security and industrial customers

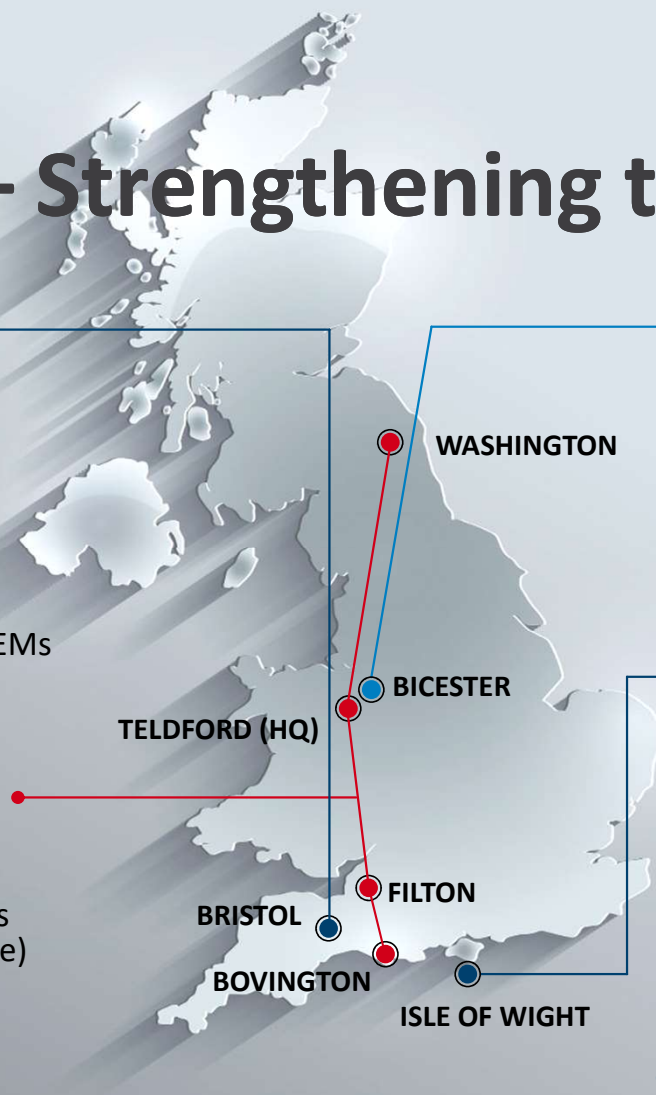

SALES 2020e: € ~200m

Home Market UK

Joint Venture with BAE Land Systems

EXPANSION OF PRODUCT PORTFOLIO

Current

- BAE UK business
- Armoured engineering vehicles and bridge-laying tanks
- AS 90 self-propelled artillery system
- Force protection components
- Services



Future

- Boxer Mechanized Infantry Vehicle (MIV)
- Challenger 2 Life Extension Program (CR2 LEP)
- Development of artillery systems
- Next generation of battle tanks

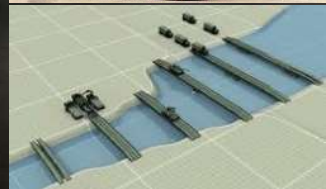



BOXER MECHANISED INFANTRY VEHICLE (MIV)

- Demand for **500 vehicles** with €1.3bn Rheinmetall share
- **Cooperation** with BAE Systems, Thales UK, Pearson Engineering, Raytheon UK and Rolls-Royce



CHALLENGER 2 LIFE EXTENSION PROGRAM (CR2 LEP)

- **Order volume** of approx. € 800 – 1,200m
- **Lifetime extension offered by British-German Team** (with Pearson Engineering, Thales UK and others)



LOGISTIC VEHICLES SERVICES

- Integrated Logistic Support for **7.500 trucks** (together with MAN Truck & Bus UK)
- **Post-design service activities**

Home Market UK

Domestic programs to load the JV

in €m

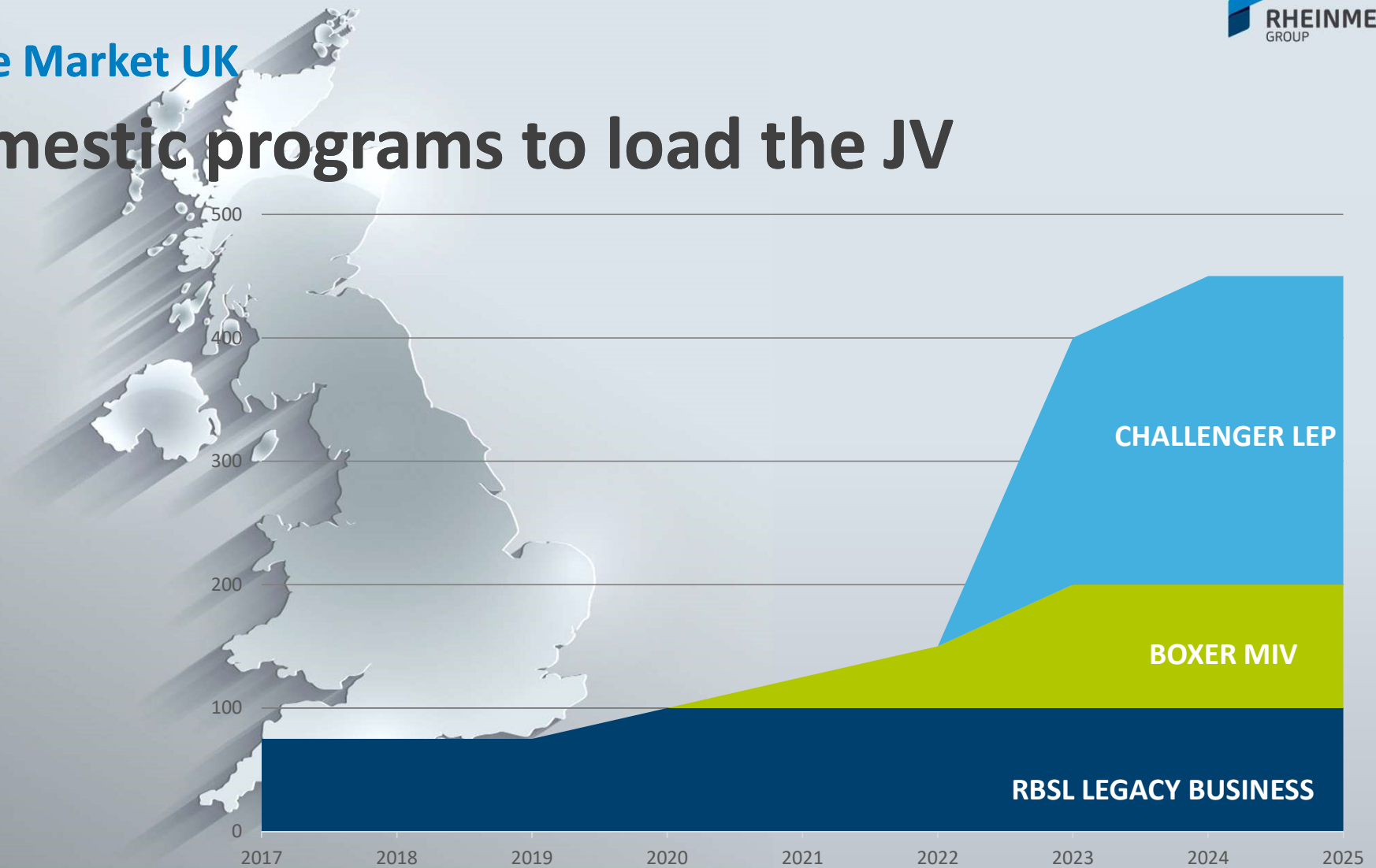

Strategic approach

Establishing attractive “HOME MARKETS”

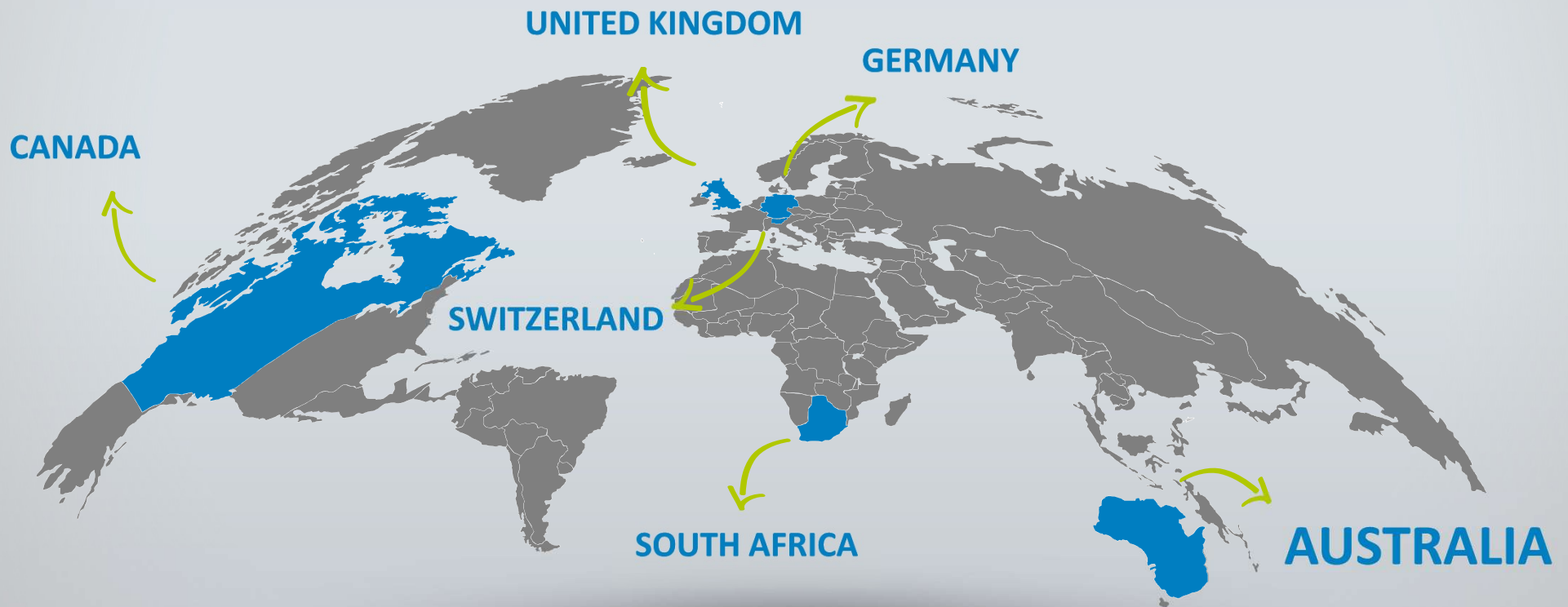

Home market Australia

Establishing a new market

SALES 2020e: € ~330m



RDA: Rheinmetall Defence Australia PTY, LTD

CAN YOU DELIVER TRUCKS?

Military Trucks

- Land 121 35 / 5B (2013/2018)
- EUR 2bn

JV Rheinmetall NIOA Munition

- 51% Rheinmetall (2017)
- Land 17: 155mm Munition: EUR 350m
- Major Munition Framework Contract: EUR 60m
- NEW Facility in Queensland

Simulation

- Simulation / Training for M1A1 Fighting Vehicles Technology

Boxer / Lance

- Land 400 Phase 2 (2019)
- EUR 2.1bn

Lynx

- Land 400 Phase 3 (2022/2023)
- EUR 5.6bn
- Down selected

MilVehCoE

Military Vehicle Center of Excellence

- Military Trucks
- Combat Vehicles
- Fleet-Service

JV Supashock

- 49% Rheinmetall (2017)
- „Brain-Trust“

SUPASHOCK

The new Brain-Trust in Australia

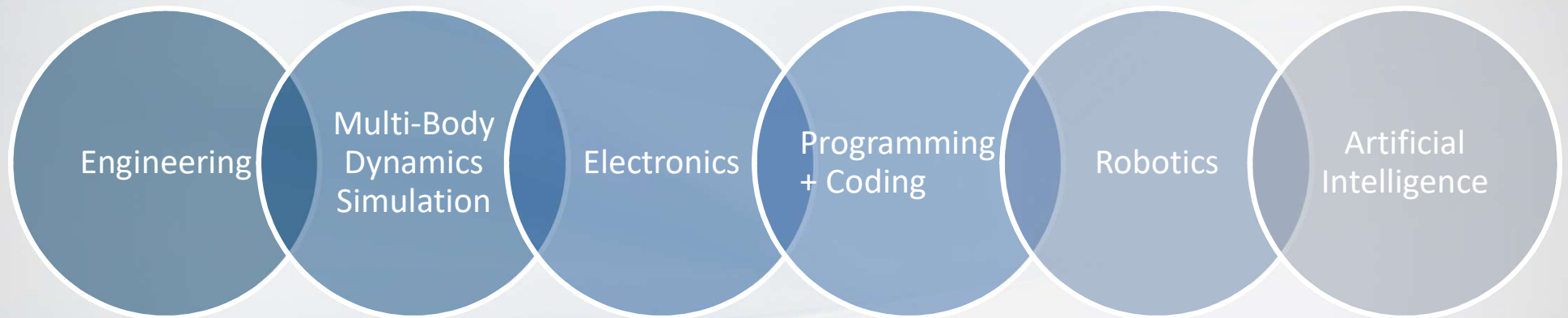

- Vehicle System Engineering
- Complete System Analysis

- Virtual Prototyping
- Performance Simulation

- Quick Prototyping
- System Architecture

- Human Machine Interface

- Advanced Driver-Assistance Systems
- Automated Load Handling
- Stabilized Gangway
- Surround Awareness Systems

- Target Localization
- Neural Networks
- Drone Detection

SUPASHOCK PRODUCTS

ACTIVE SUSPENSION (CIVIL/MILITARY)



OEM SUSPENSION



ACTIVE RIDE LEVELING
SYSTEM



4x4 DAMPERS



STREET
PERFORMANCE

LIGHT WEIGHT RUNNING GEAR



SUPPORT ROLLER



ROAD WHEEL ARM
& ASSEMBLY

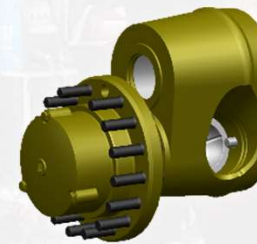

IDLER WHEEL ARM



TRACK TENSIONER

SUPASHOCK PRODUCTS

ALHS: AUTOMATED LOAD HANDLING SYSTEM



DEFENCE LOGISTICS: CRANE HANDLING SYSTEM (Lynx crane)

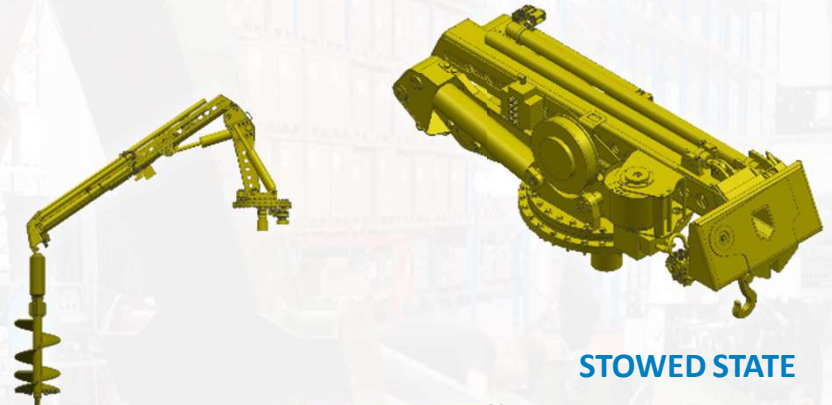

STOWED STATE

AUGER

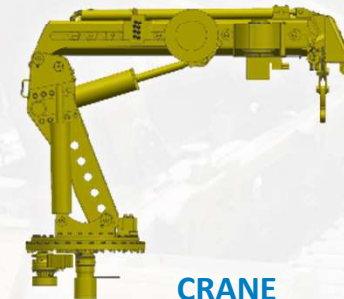

CRANE

SUPASHOCK PRODUCTS

CONCEPT: MOTION STABILISED GANGWAY

AUTONOMEIOUS OEM DRIVING

- 3D Camera System
- Natural Frequency Control
- Active Damping Capability

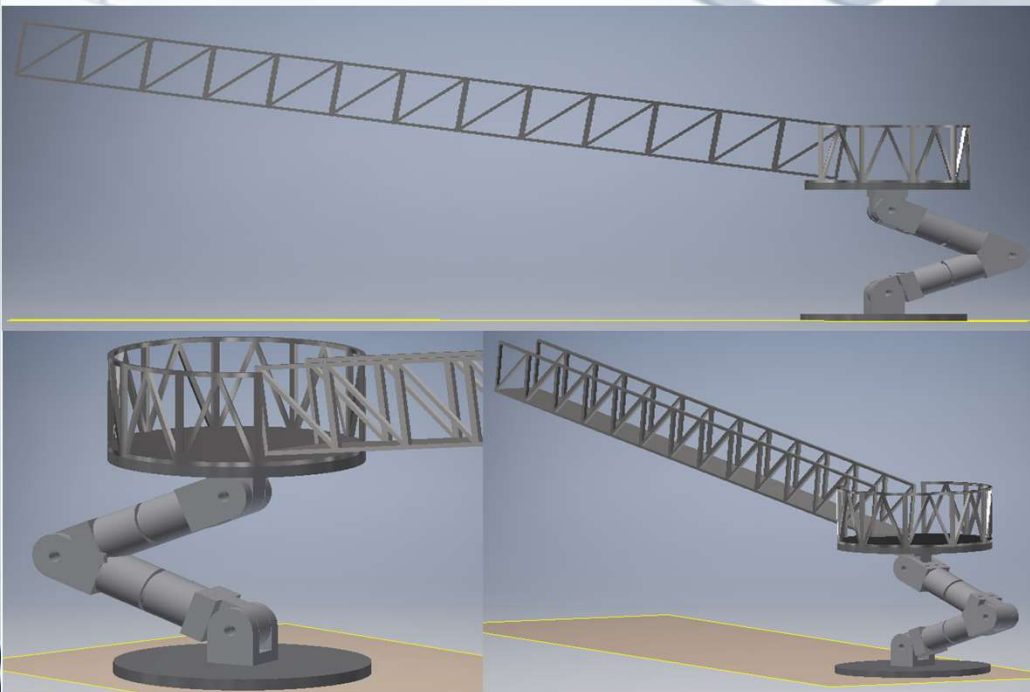

A vibrant blue nebula with a dark dust ring, set against a starry night sky. The nebula features a prominent ring of dark dust in the upper left quadrant, surrounded by glowing blue gas. The background is filled with numerous stars of varying brightness.

For the near Future

A Rheinmetall Leopard 2 tank is shown from a front-three-quarter perspective in a desert environment. The tank is painted in a camouflage pattern of dark green, brown, and tan. Its main gun is elevated and pointed towards the sky. The scene is dramatically lit from behind, creating a silhouette effect and highlighting the tank's contours against a cloudy, sunset or sunrise sky. The tank's headlights are illuminated, casting a bright glow. The background shows a flat, arid landscape with sparse vegetation.

Rheinmetall DEFENCE

DEFENCE

MANAGING THE SUPER CYCLE

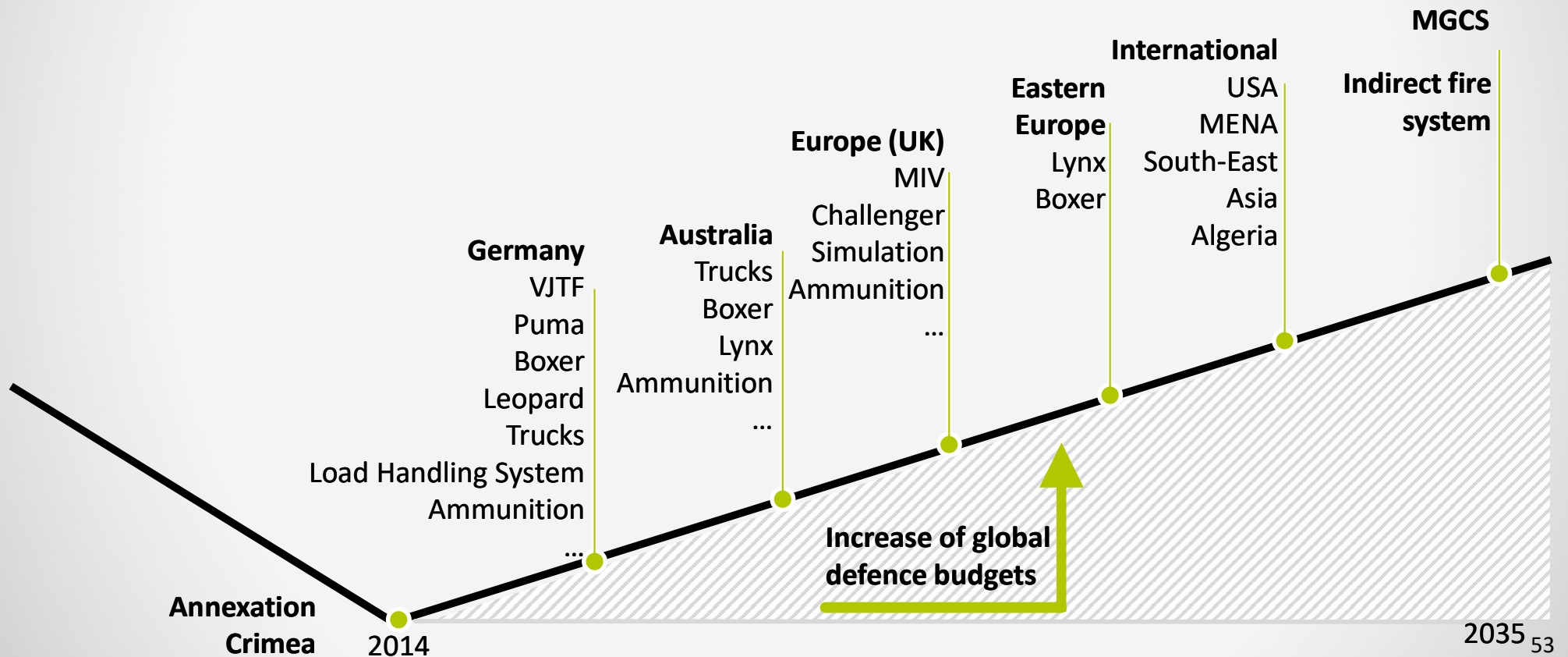

DEFENCE

We promised and delivered!



Australian Boxer EUR 2.1bn



MIV EUR 1.3bn



Trucks Germany & Australia
EUR 2.6bn + +



VJTF PUMA & IdZ EUR 0.4bn + +

DEFENCE ROADMAP

German defence budget investive expenses and Rheinmetall-share

in €m

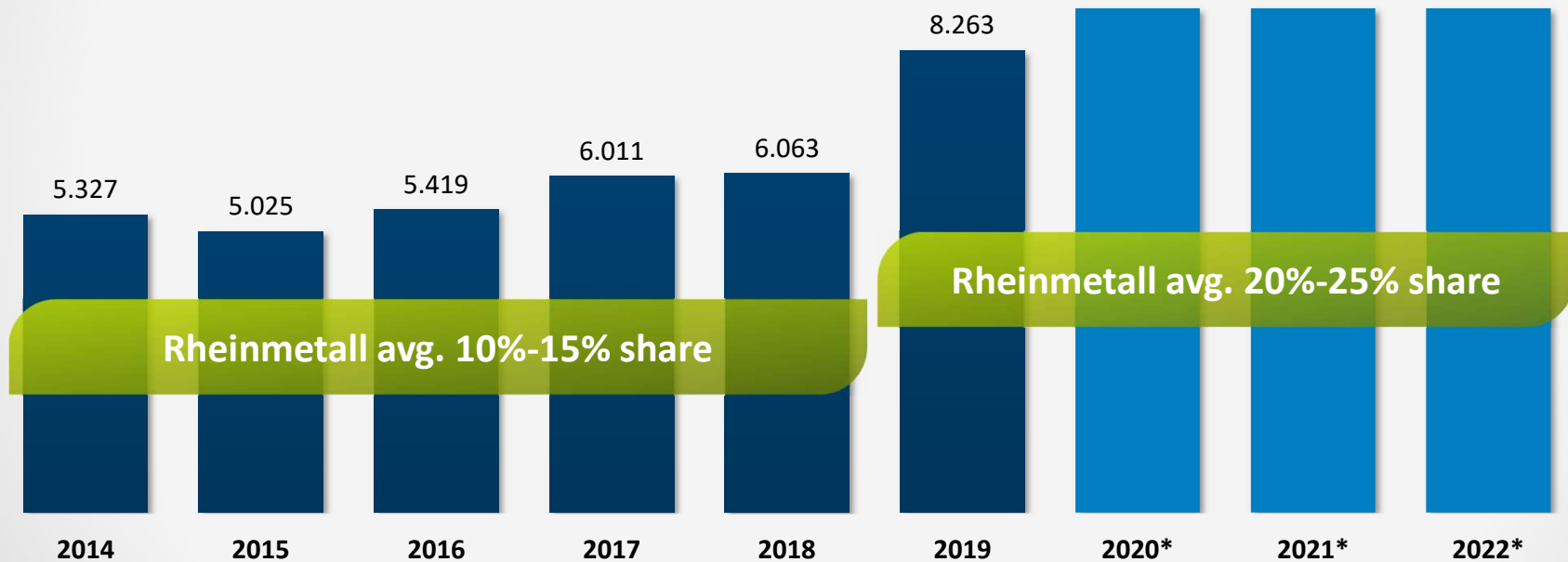

DEFENCE MARKET

SUPER CYCLE GROWTH POTENTIALS

Sales in €bn

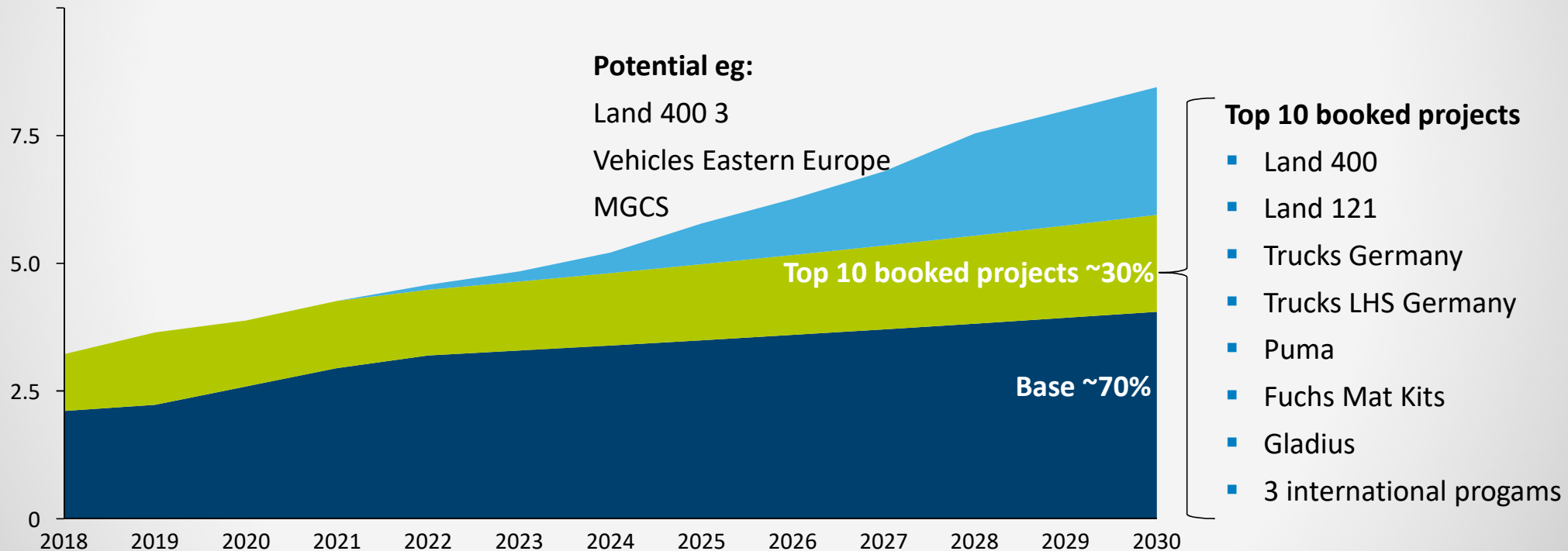

Rheinmetall

AUTOMOTIVE



AUTOMOTIVE

HOW TO FILL THE GAP

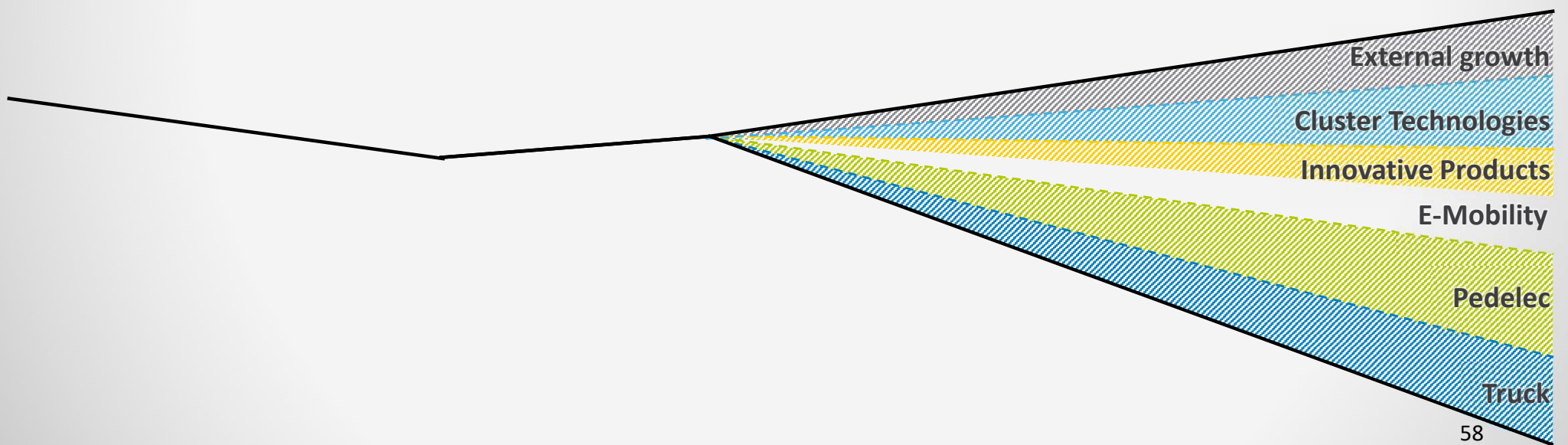

AUTOMOTIVE

Regional Overview flattish market until 2022

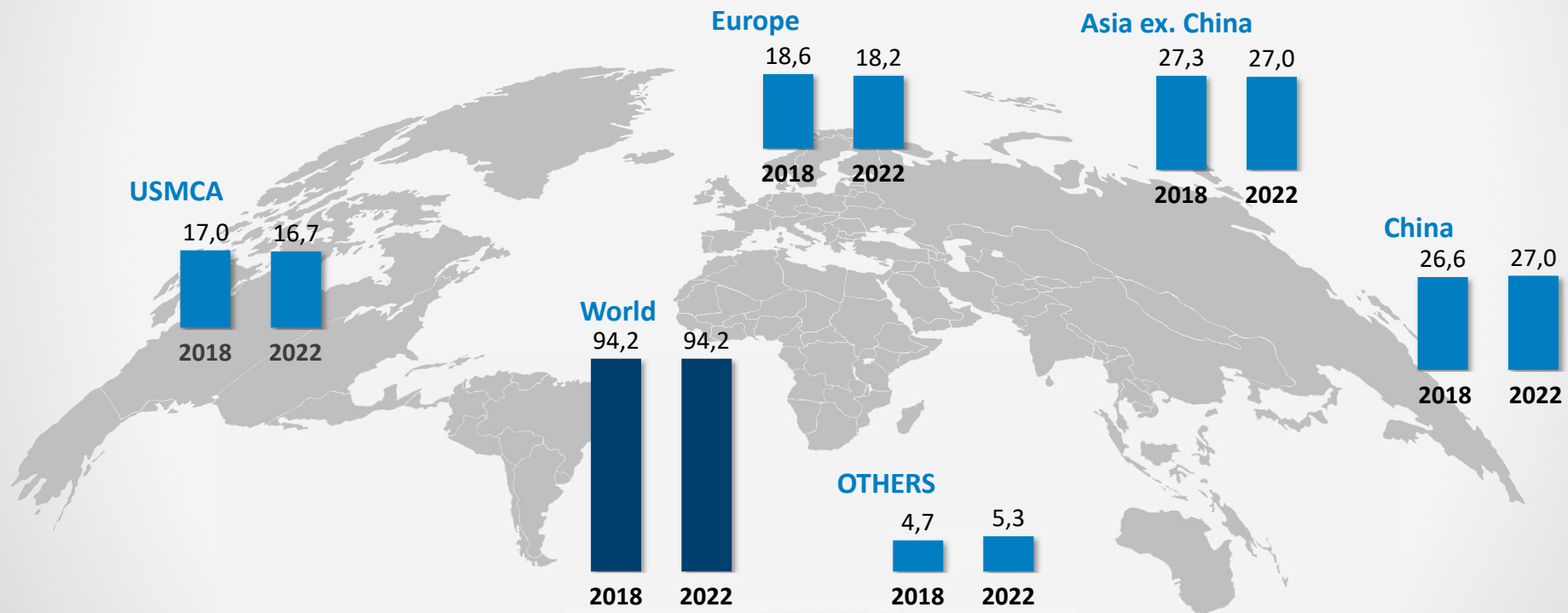

Source: IHS September 2019

AUTOMOTIVE

Booked Business Mechatronics

Booked Business

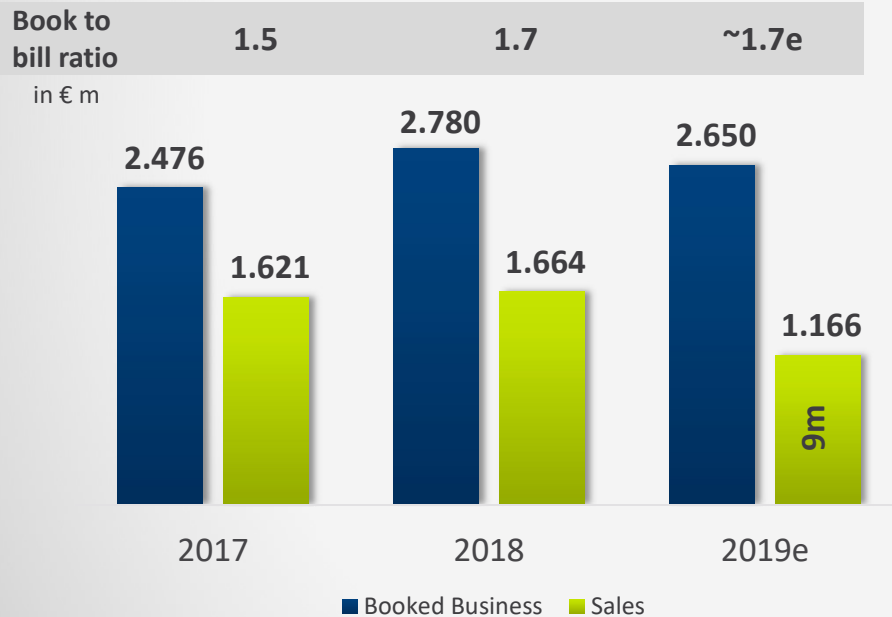

by Propulsion Type 2018 + YTD 2019

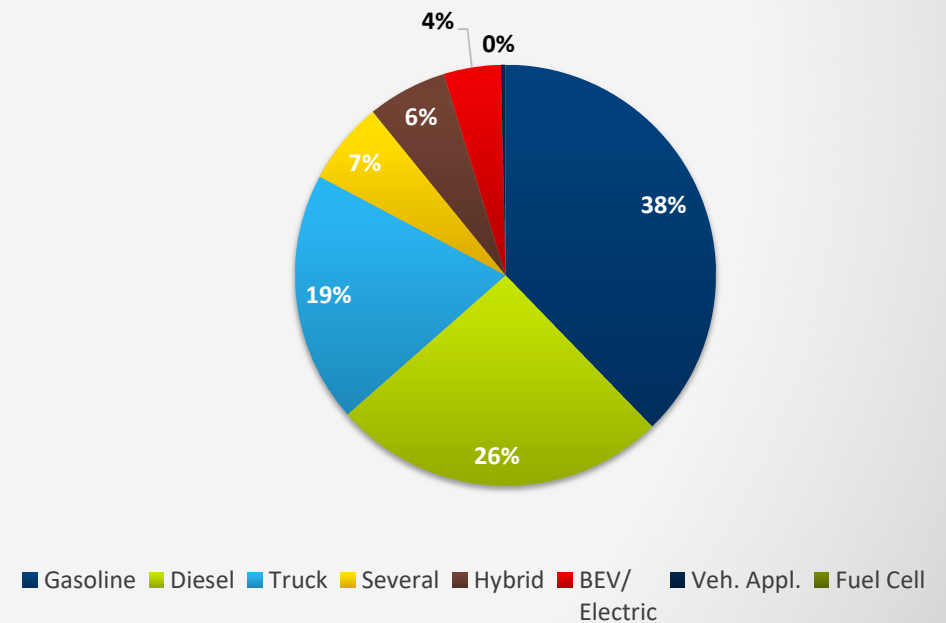

AUTOMOTIVE

Booked Business Hardparts

Booked Business

by Propulsion Type 2018 + YTD 2019

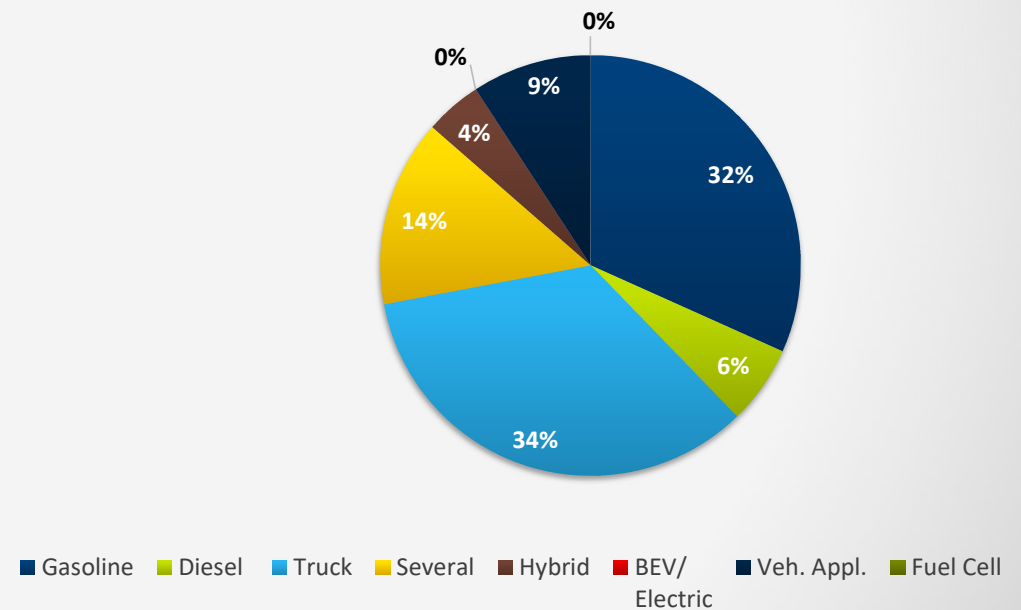



Automotive

TRUCKS

AUTOMOTIVE TRUCK product portfolio

HARDPARTS

Permaglide bearings
for truck compressors
and truck hydraulics



Aluminum pistons



Steel pistons



Piston rings
Cooperation with
Riken



Bushings for
injection pumps



Main-bearings



Connecting rod bearings

Bearings for seat adjustments and doors

EGR cooler modules
and mixer modules



Dual poppet valves



EGR reed valves



High
performance
actuators



Pressure
regulating
valves



Electrical
bypass
valves

Cylinder
bore coating



Main coolant
pumps



Auxiliary
coolant pumps



Electrical oil pumps



Coolant
valves

Variable Valve Control



Exhaust gas flaps

Hydraulic valves



MECHATRONICS

AUTOMOTIVE

Worldwide **TRUCK PRODUCTION** development

Truck production according to IHS (in m units)

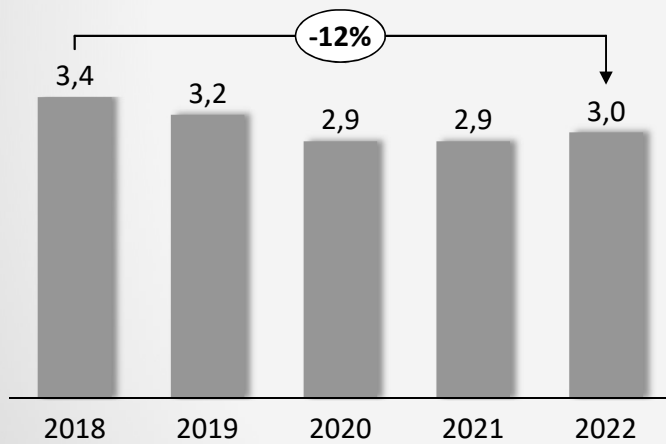

Rheinmetall truck sales estimates in €m

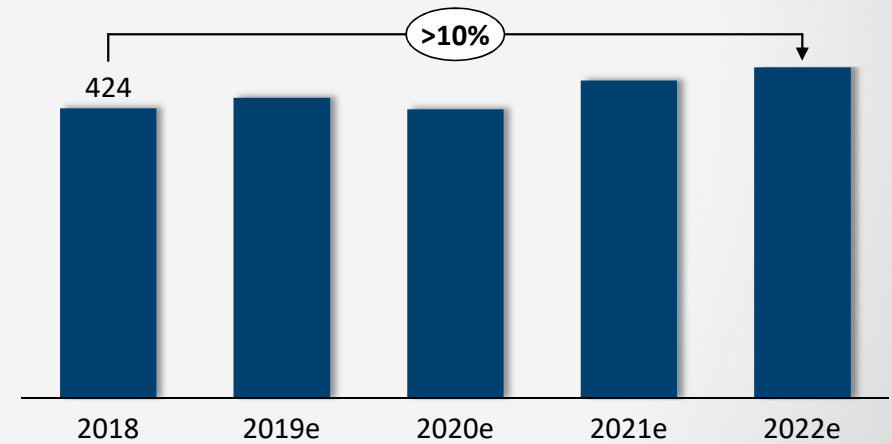

Source: IHS September 2019

AUTOMOTIVE CHINA



LIGHT VEHICLE VOLUME FORECAST CHINA

China LV
Volume Evolution
(m units)

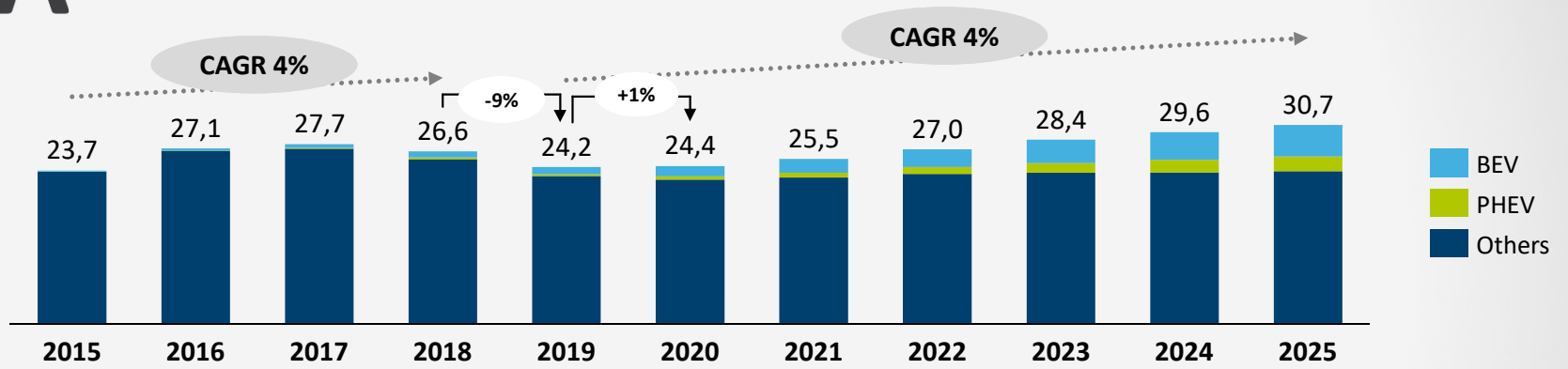

China NEV
Volume Evolution
(m units)

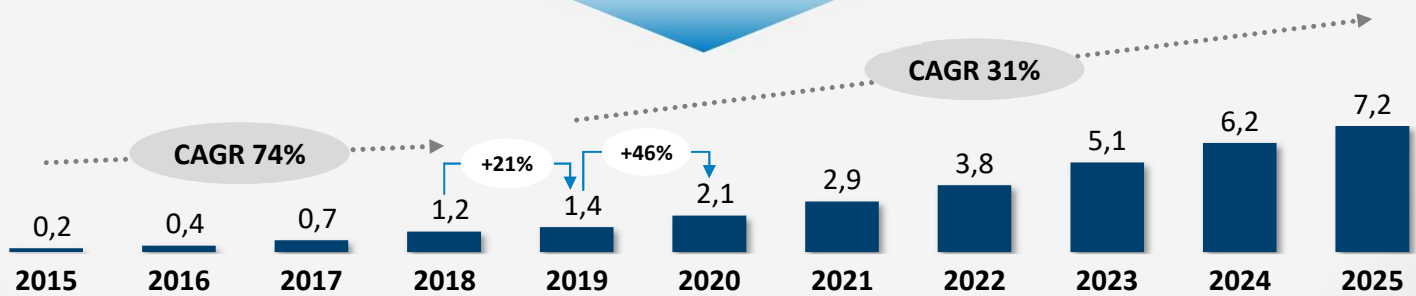

Source: IHS October 2019

HIGHLIGHTS

CHINA

Partner of local big players SAIC and HASCO

Biggest casting capacities in China – technology leader

Regulation (China 6) – provides substantial growth potential for mechatronics division

Strong demand for NEV products

China Story on track: product pipeline supports growth ambitions

SALES EXPECTATION BY DIVISION CHINA

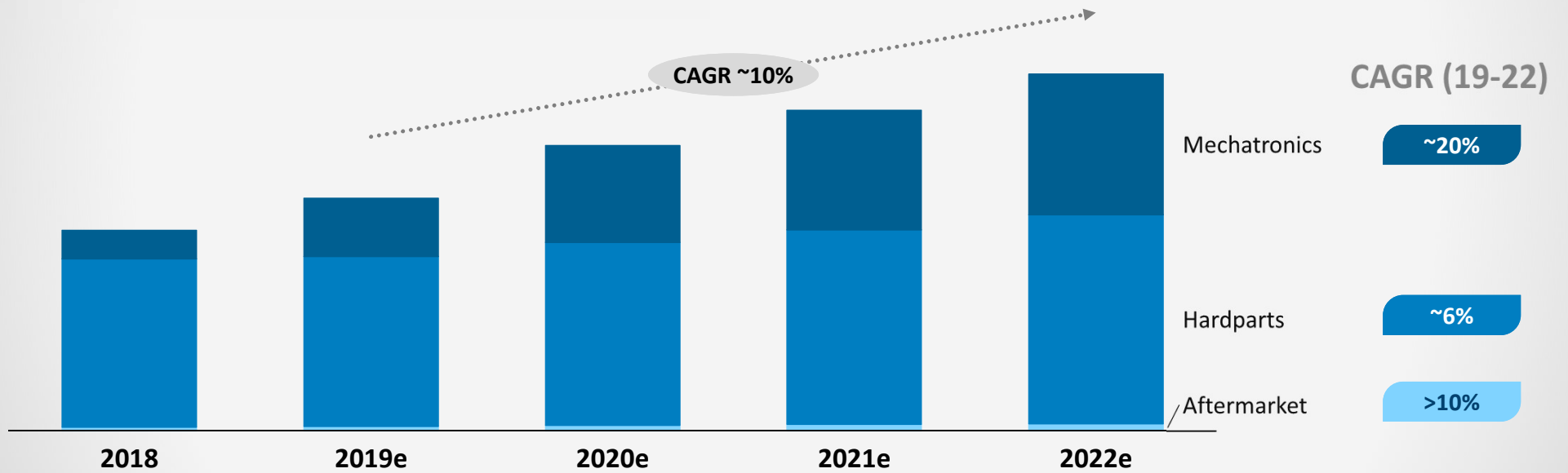

Mobility | Security | Passion

Mobility technologies to drive.
Security technologies to protect.
Passion for both.