

Automotive Presentation

02 August 2016



System leadership with most balanced portfolio in the market



2015 global market shares

		2014	Delta	2015
1	NXP (incl. FSL)	13.3%	+0.9%	14.2%
2	Infineon	10.5%	-0.1%	10.4%
3	Renesas	12.0%	-1.7%	10.3%
4	STMicro	7.8%	-0.1%	7.7%
5	TI	6.1%	+0.9%	7.0%
6	Bosch	6.2%	-0.8%	5.4%

2015 market shares by product category

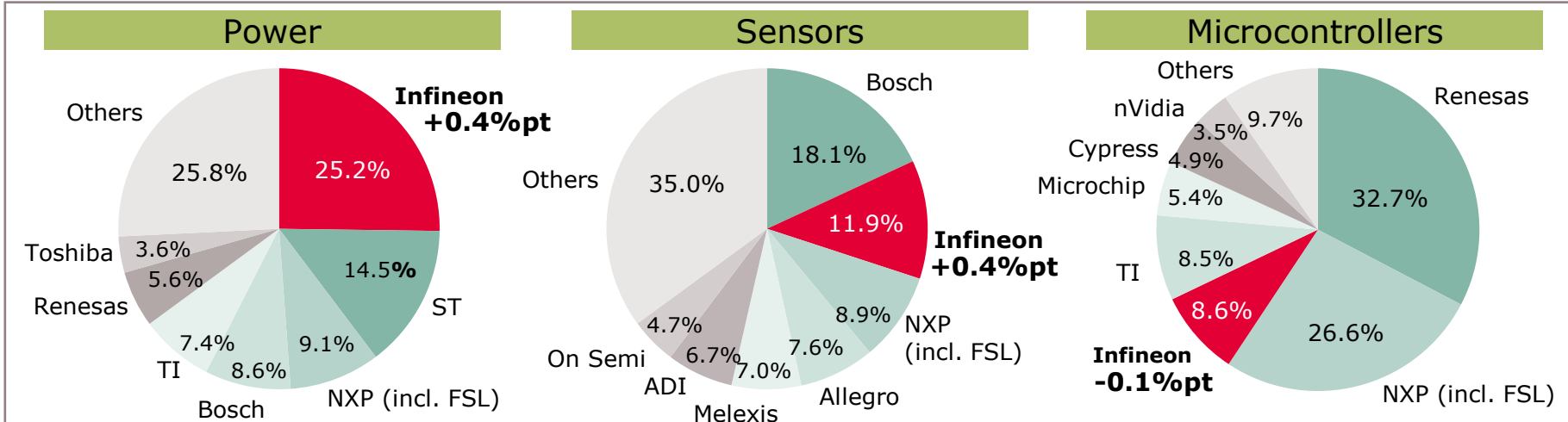

Source: Strategy Analytics, "Automotive Semiconductor Vendor Market Shares", April 2016

Four megatrends are shaping the automotive market, significantly increasing the semi content per vehicle

ADAS/Autonomous driving

- › From ADAS to semi-automated and finally autonomous driving
- › Every world region is striving for “0-accident”



xEV/eMobility

- › Mandated CO₂ reductions make electrification of powertrain inevitable

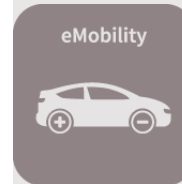

- › Advanced connectivity is driven by making the car part of the Internet
- › The car will be fully connected (V2I, V2V, in-vehicle)



Car Security

- › Increased connectivity and software content increase risk exposure to hackers
- › Internal/external connectivity must be secured



Connectivity

Advanced security

ADAS system overview

Sense Compute Actuate

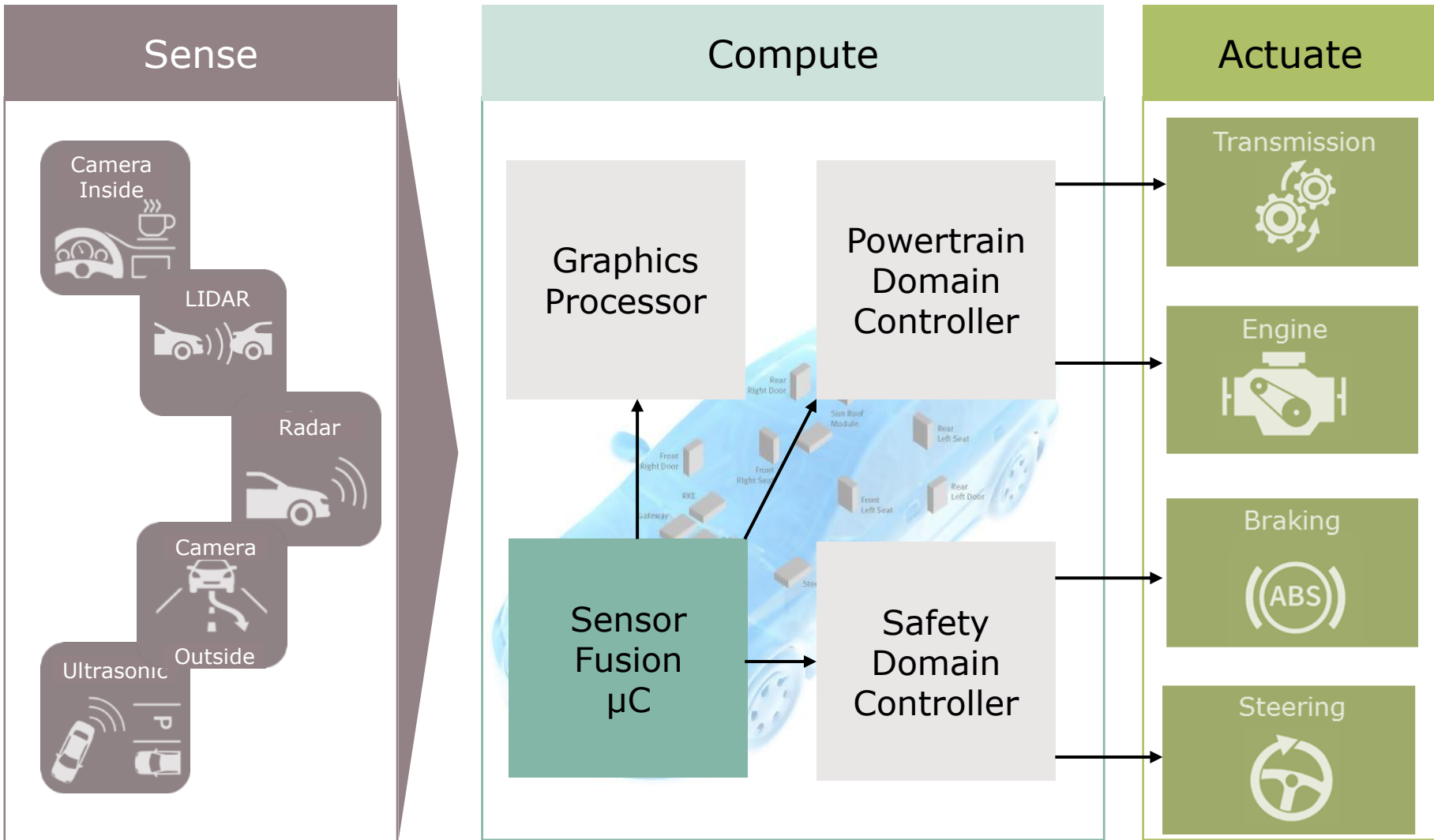

More sensors required for each automation level – sensor “cocoon” in level 4/5

Sense

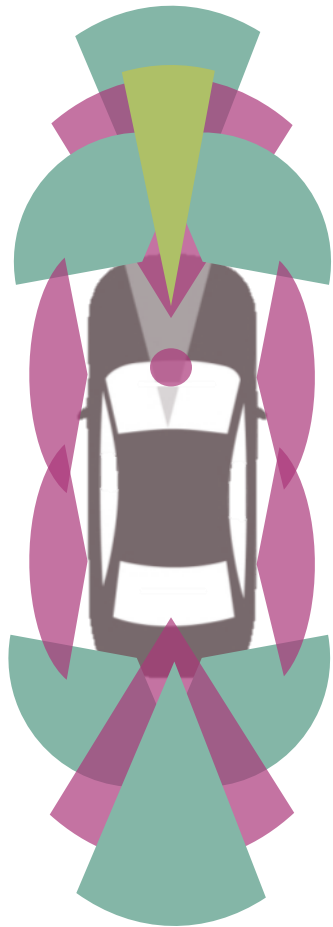

Sensor technologies	2015 Euro-NCAP*	2018 Euro-NCAP*	Level 2	Level 3	Level 4/5
Front looking camera	0.5	1	1	1	1
Front looking radar	0.5	1	1	1	1
Front looking lidar	–	–	–	–	1
Surround camera	–	–	–	–	4
Corner radar	–	2	2	4	4
Surround radar	–	–	–	–	6
Rear looking camera	–	–	–	1	1
Rear looking radar	–	–	–	–	1
Driver monitoring Camera	–	–	–	1	1
V2X sensor	–	–	–	–	1
Parking aid	Up to 12 ultrasonic sensors per car				
Automated parking	Potential future replacement by RF CMOS radar				

Up to 12 SiGe radars per vehicle (24/77 GHz)

■ Radar ■ Camera ■ Lidar

* Euro-NCAP is focusing on collision avoidance, requirements are increasing over time

Infineon market leader in radar; 20m sensor chips sold; ~50% CAGR₁₆₋₂₁ based on design wins*

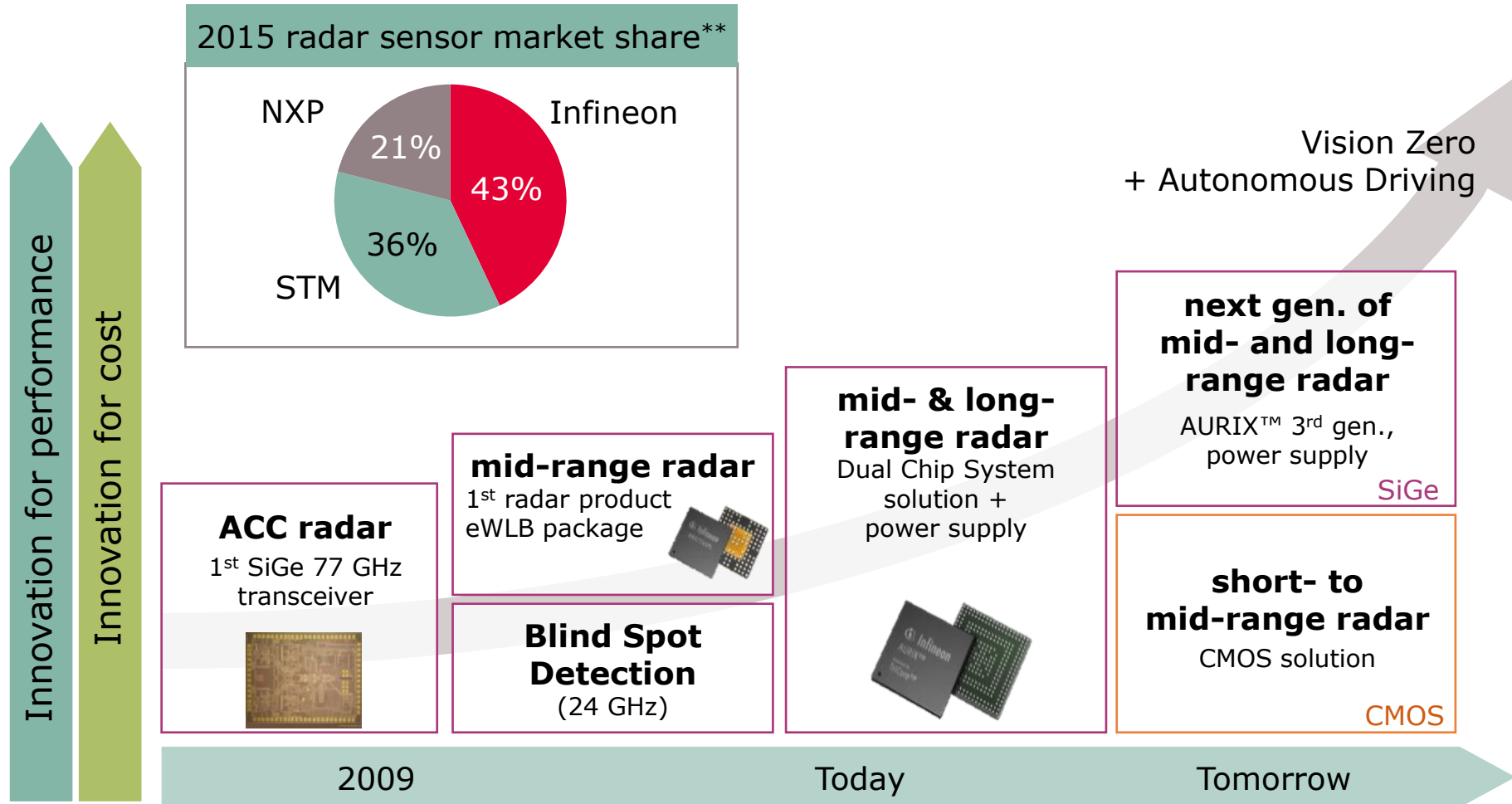

* Refers to 77 GHz radar sensor chip market

** Source: IHS Markit, "Advanced Driver Assistance Applications Sensor Market Database – H2 2015", February 2016

Depending on test cases, AEB will be either BiCMOS or CMOS

	Sense		
	SiGe BiCMOS		CMOS (< 40 nm)
77 GHz performance	excellent		ok
f_{\max}	> 400 GHz		> 300 GHz
Noise	1x		2x .. 3x
System-on-chip capabilities	good		excellent
77 GHz automotive-qualified product	in high volume production		not yet available
Application	ACC, Highway Assist	AEB	Parking Assist, Blind Spot Detection

- > Today, SiGe is state of the art.
- > Beyond 2020, CMOS will find its sweet spot in 360° applications.

Infineon's automotive offering in ADAS camera systems



Sense

Compute

Driver monitoring

- > Most robust detection of head position, head orientation and eye closure
- > Observe the state of the driver and passengers
- > Optimize head-up displays and augmented reality to driver's head position



Kostal camera system



REAL3™ sensor

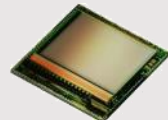

Front camera

- > AURIX™ microcontroller is today the reference for safety allowing ASIL-D systems
- > The safe & secure microcontroller is represented in most of today's camera systems
- > OEMs prefer software on AURIX™

Image processor
e.g.



Infineon safe &
secure µC



Secure μ Cs from Infineon offer the required safety and necessary scalability

Compute

Sensor fusion

AURIX™ as main or host controller

Radar & camera

AURIX™ as main* or host controller

* for radar

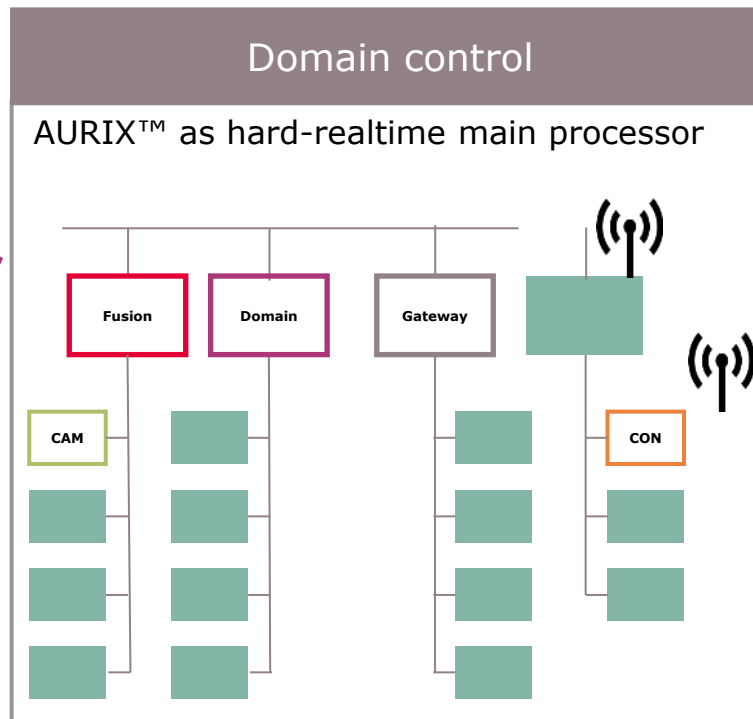

Connectivity gateway

AURIX™ as hard-realtime main controller

Always-on connectivity

AURIX™ as host controller



Safety
 Security
 Automotive Quality

Infineon AURIX™ microcontrollers make autonomous driving reliable



Compute



The central driver assistance ECU ("zFAS*") is the core of future systems for piloted driving for Audi

Key components from Infineon, designed for reliability:

- › AURIX™ controller as decision maker and interface to the car architecture
- › DC-DC – safety system supply



Strategic cooperation with TTTech to enable zFAS* based architecture and position Infineon as leading supplier

* zFAS = zentrales Fahrerassistenzsystem

30%+ higher BoM on fail operational systems in level 3-compliant vehicles



Sense

Compute

Actuate

Electric power steering as an example for Infineon's P2S* approach

System

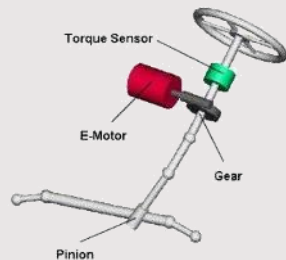

Electric motor

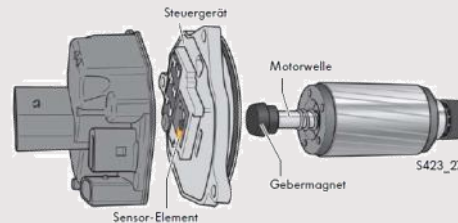

Courtesy: ZF Lenksysteme

Electronic control unit



Sense

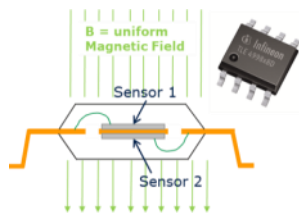

2 independent dies

Compute



multicore

Actuate



multi-phase control

Safe power supply

Infineon with 100% BoM coverage

*Product to System (P2S): The shift from product thinking to system understanding is the core element of Infineon's strategy.

ADAS semi growth driven by radar and camera sensor modules

Average ADAS semiconductor content per level of automation

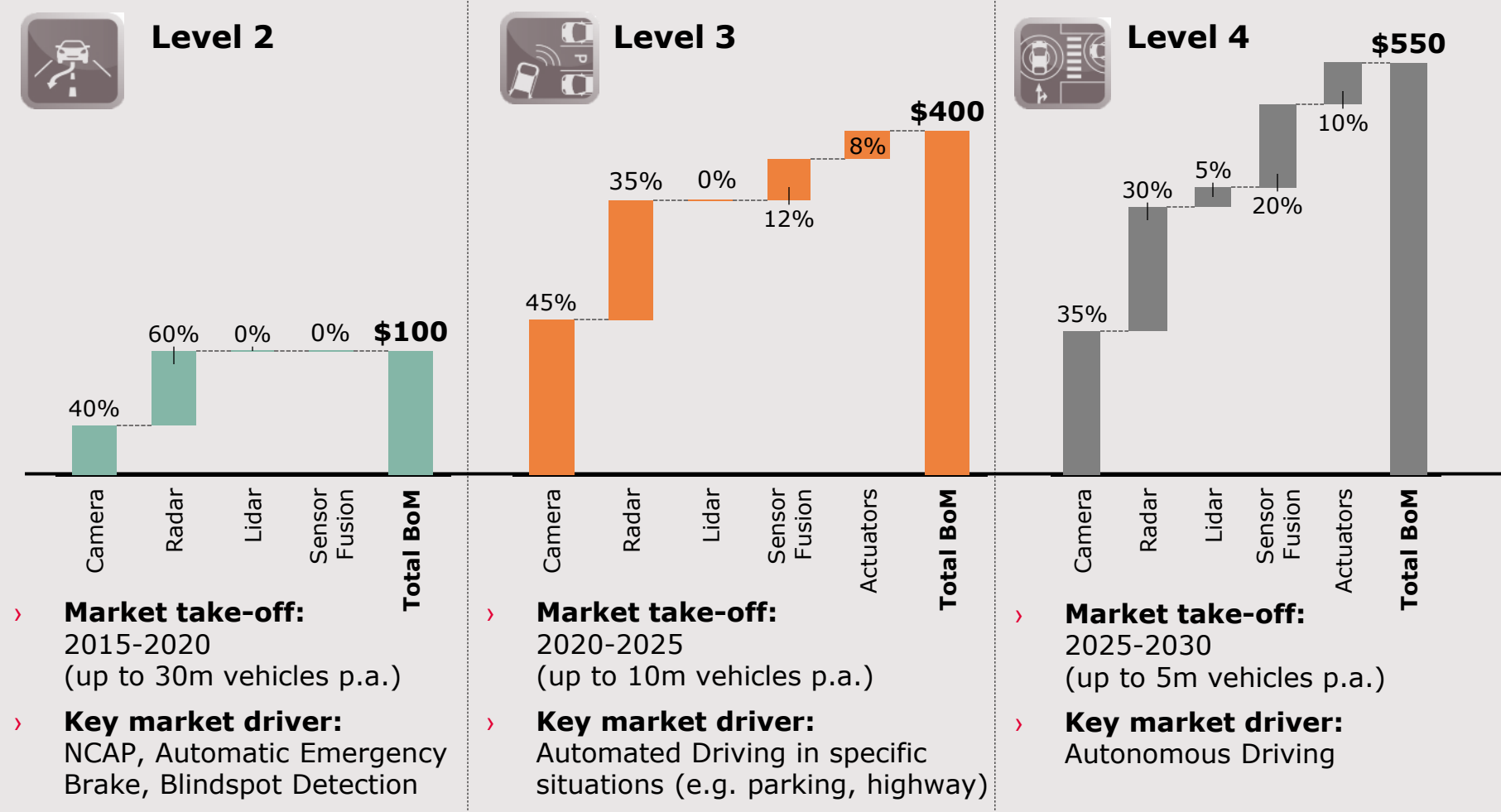

ADAS system chipset coverage by Infineon

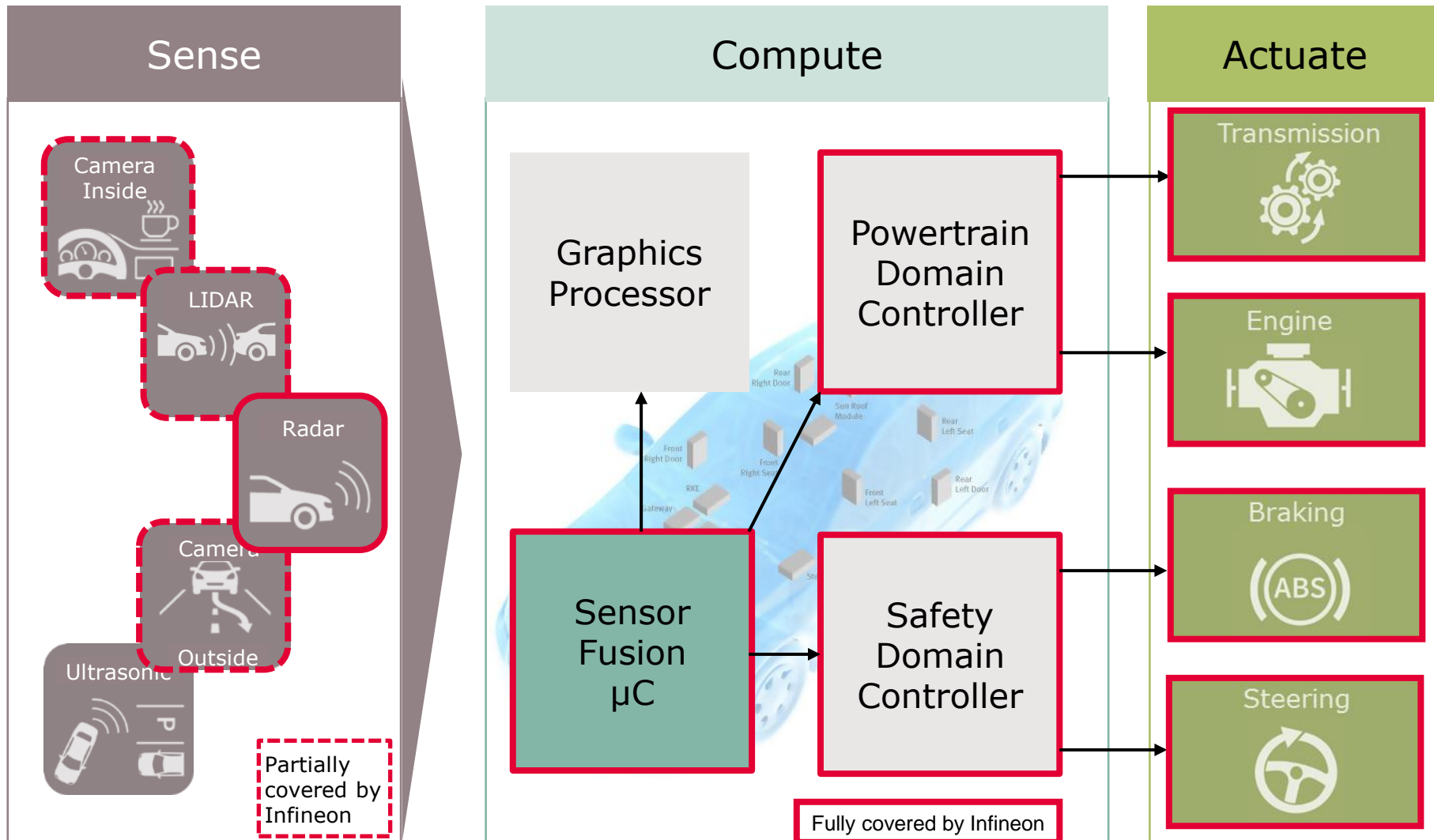

Four megatrends are shaping the automotive market, significantly increasing the semi content per vehicle

ADAS/Autonomous driving

- › From ADAS to semi-automated and finally autonomous driving
- › Every world region is striving for “0-accident”

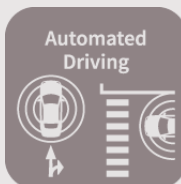

xEV/eMobility

- › Mandated CO₂ reductions make electrification of powertrain inevitable

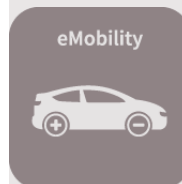

- › Advanced connectivity is driven by making the car part of the Internet
- › The car will be fully connected (V2I, V2V, in-vehicle)



Car Security

- › Increased connectivity and software content increase risk exposure to hackers
- › Internal/external connectivity must be secured



Connectivity

Advanced security

We will experience a shift from Si IGBT to SiC MoSFET

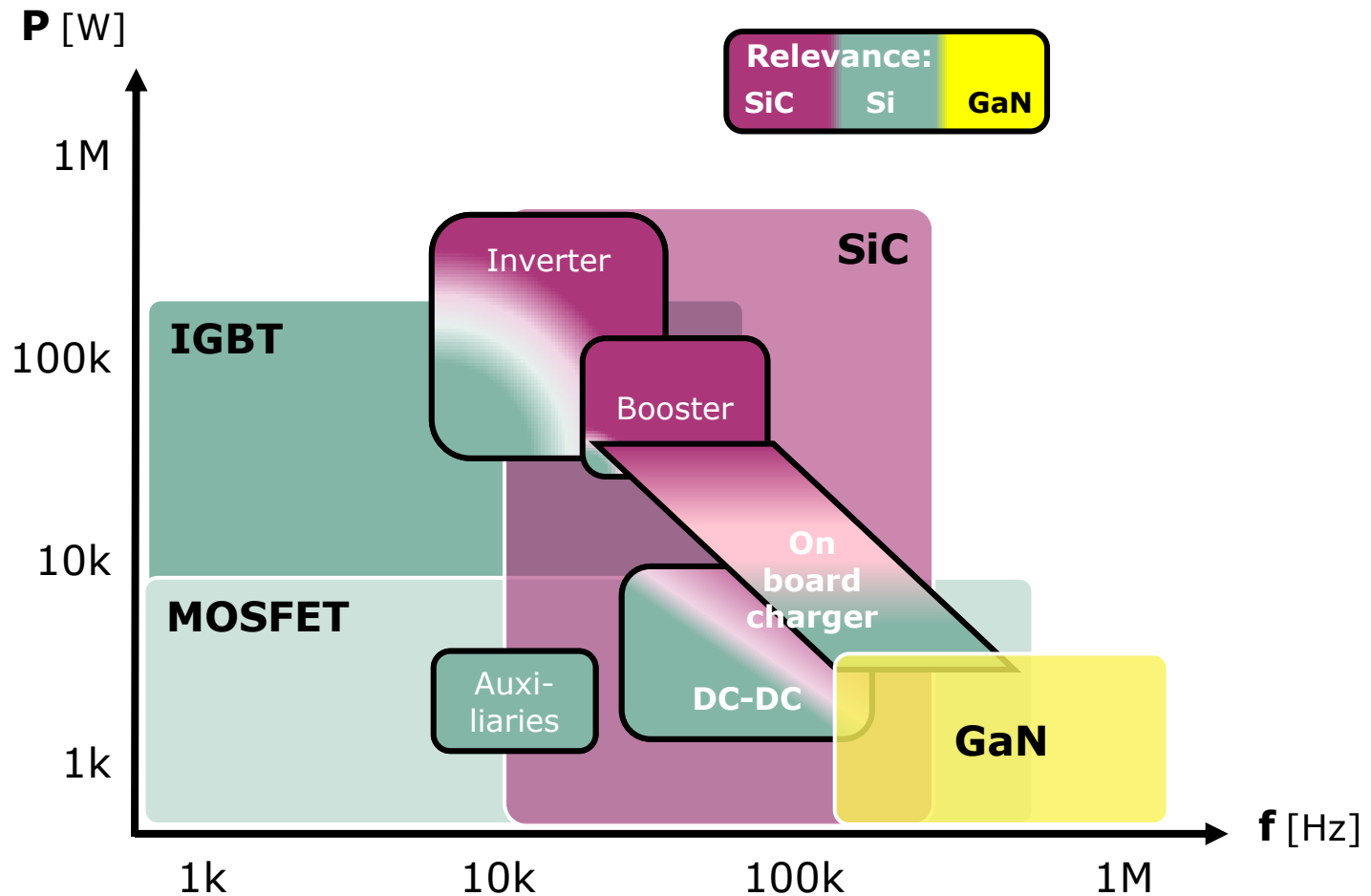

Independently from the voltage class, HEV subsystems are not in the sweet spot of GaN technology

xEV growth driven by power semis

Average xEV semiconductor content by degree of electrification

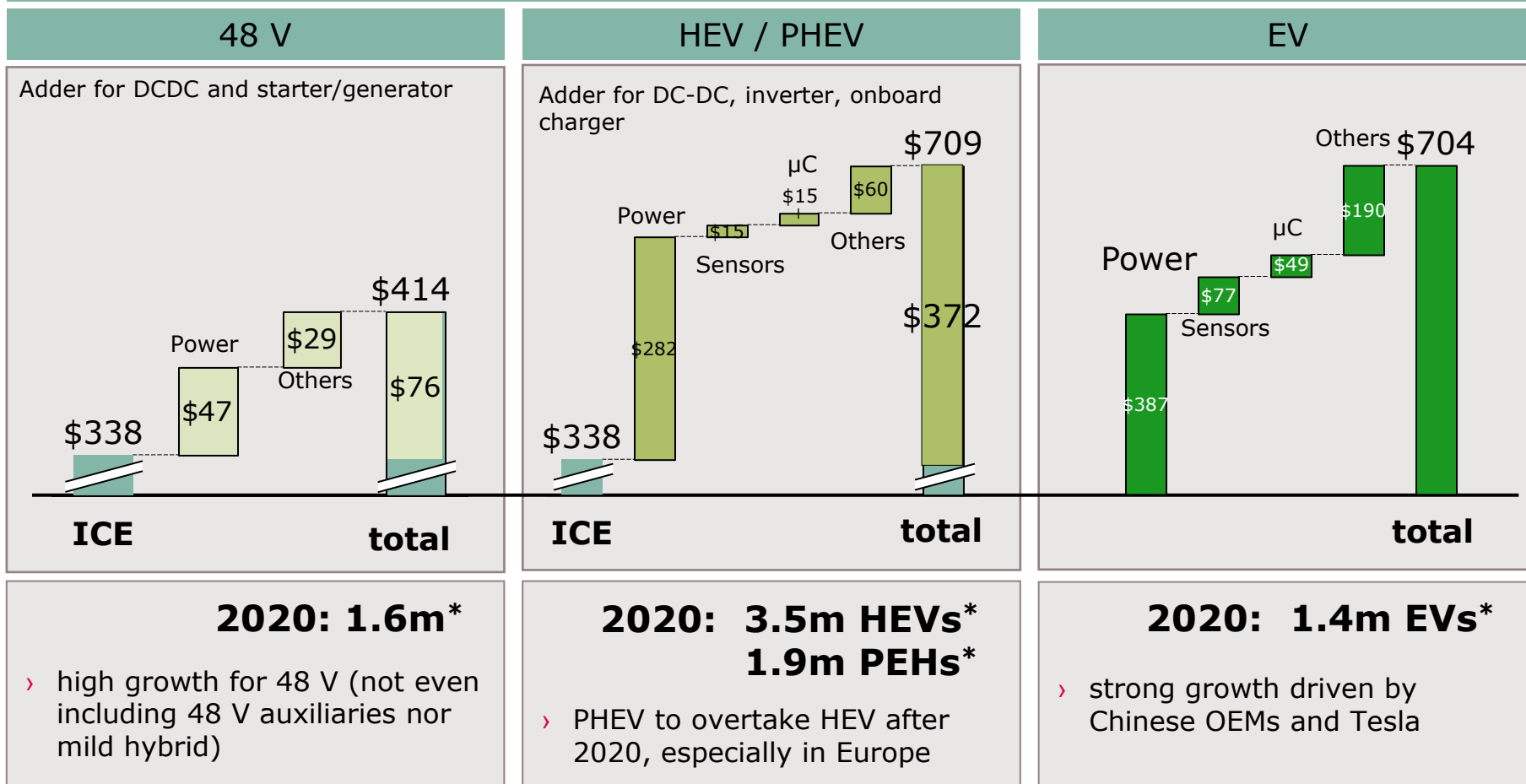

* Source: IHS Markit, "Alternative Propulsion Forecast", January 16, expected number of vehicles

#1 semi supplier of German premium OEMs

Powered by Infineon

> \$500 semiconductor content

Non-power

22%

78%

Power



740e

Plug-in hybrid

Courtesy: BMW

The expected big expansion of PHEV model line-up from premium OEMs will boost Infineon revenues

Four megatrends are shaping the automotive market, significantly increasing the semi content per vehicle

ADAS/Autonomous driving

- › From ADAS to semi-automated and finally autonomous driving
- › Every world region is striving for “0-accident”



xEV/eMobility

- › Mandated CO₂ reductions make electrification of powertrain inevitable

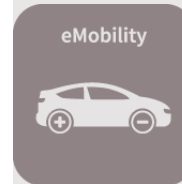

- › Advanced connectivity is driven by making the car part of the Internet
- › The car will be fully connected (V2I, V2V, in-vehicle)



Car Security

- › Increased connectivity and software content increase risk exposure to hackers
- › Internal/external connectivity must be secured



Connectivity

Advanced security

The connected car and move to open systems offer many use cases for our customers

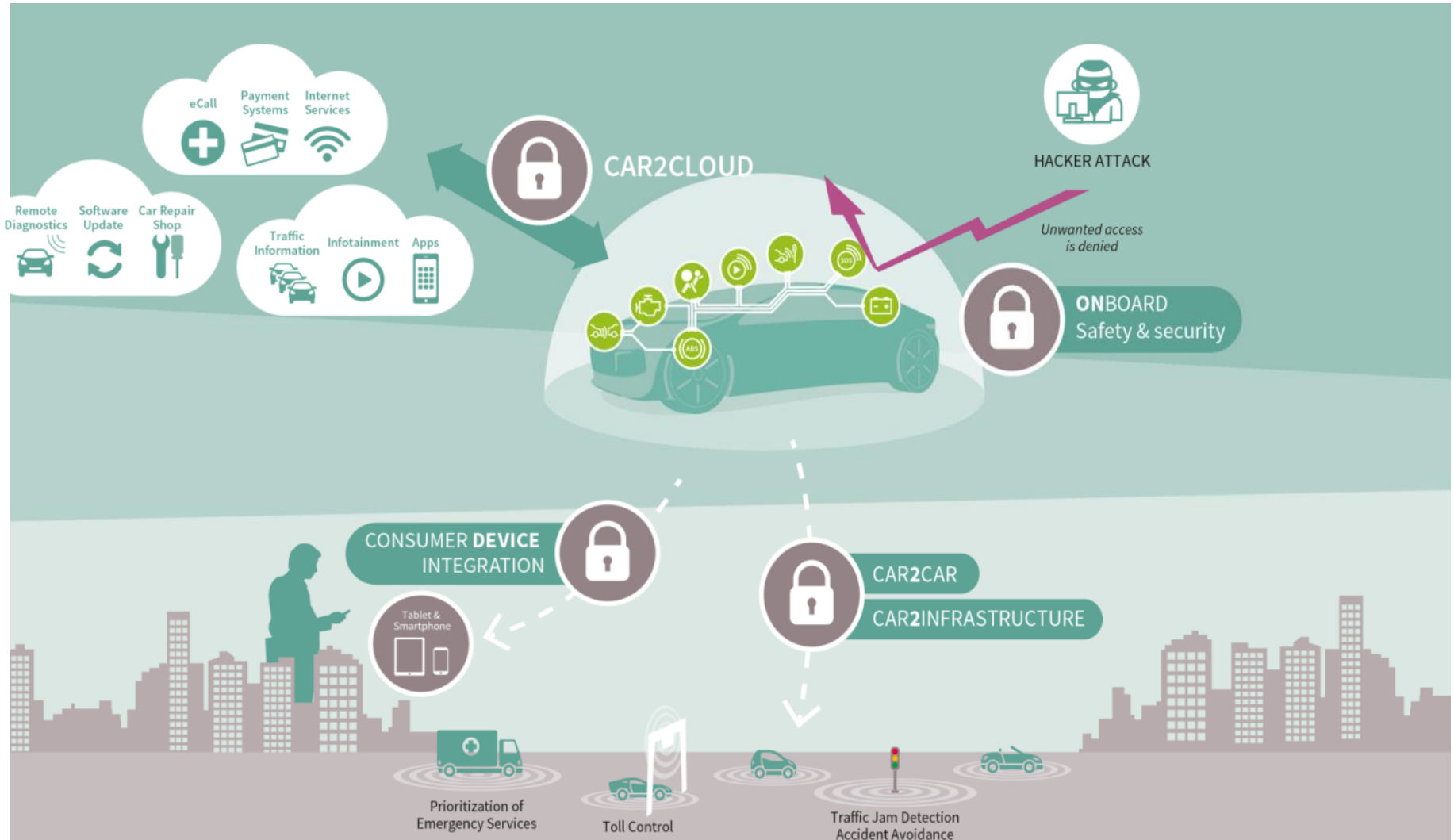

Various security tools have to be added on the way to a secure architecture

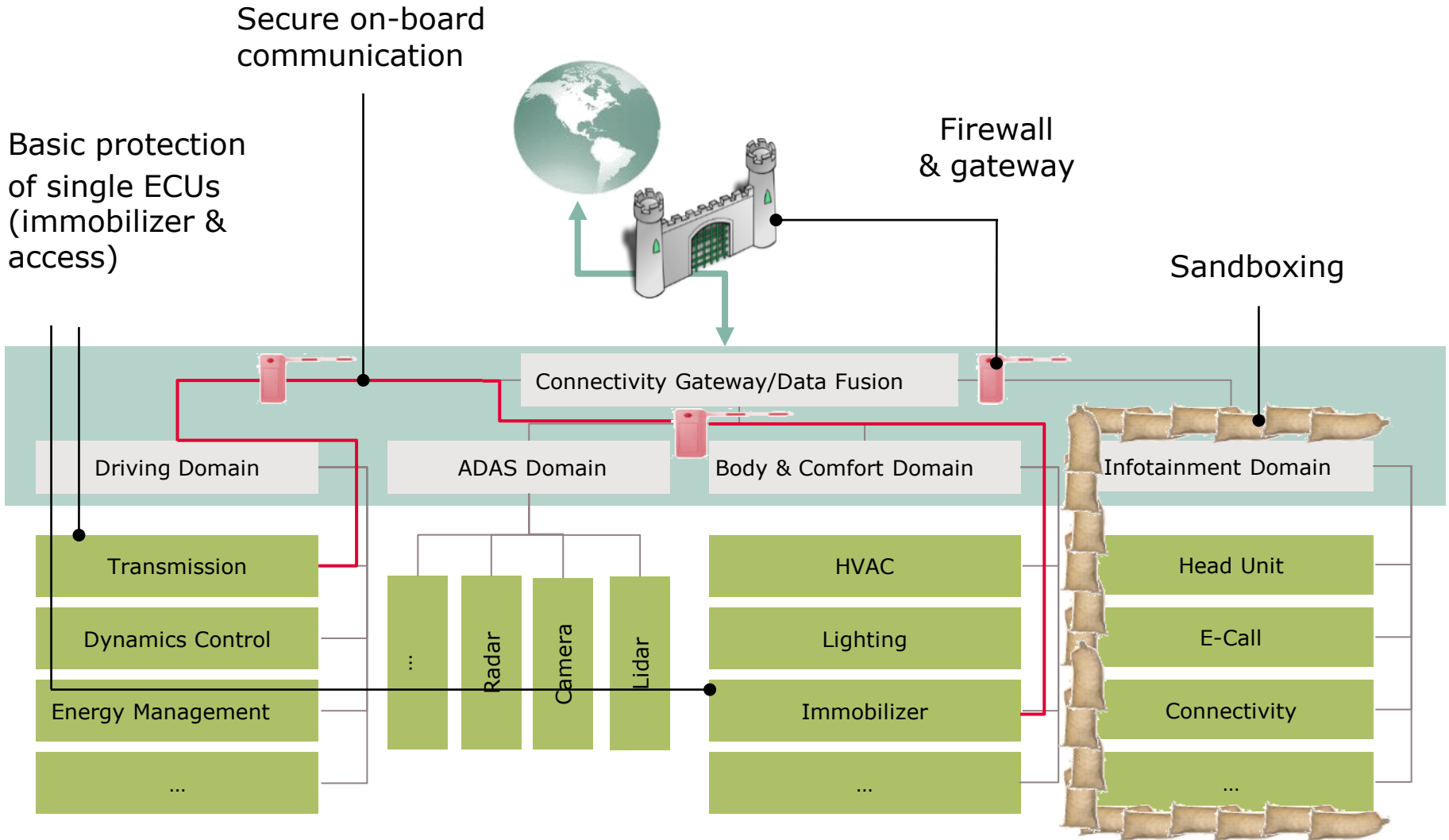

Various security tools have to be added on the way to a secure architecture

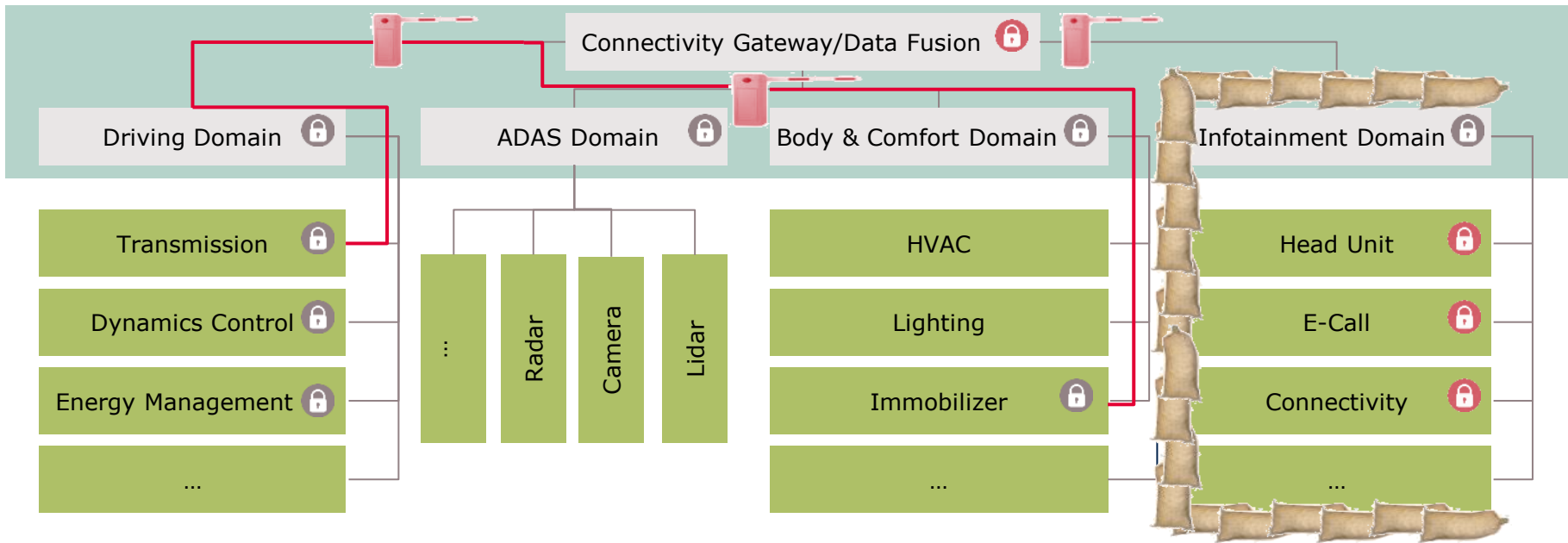

Trust anchors



Protected Execution Environments hosting

- > Key storage and related cryptographic operation
- > Security applications



Integrated on MCU

- > High speed
- > Secure onboard communication
- > Logical security



Discrete Security Controller

- > External communication
- > Protecting high value
- > By certified hardware security

Enabling the root of trust for internal and external communication

Infineon is ideally positioned to benefit most from megatrends ADAS, xEV, and security



ADAS/autonomous driving semi market

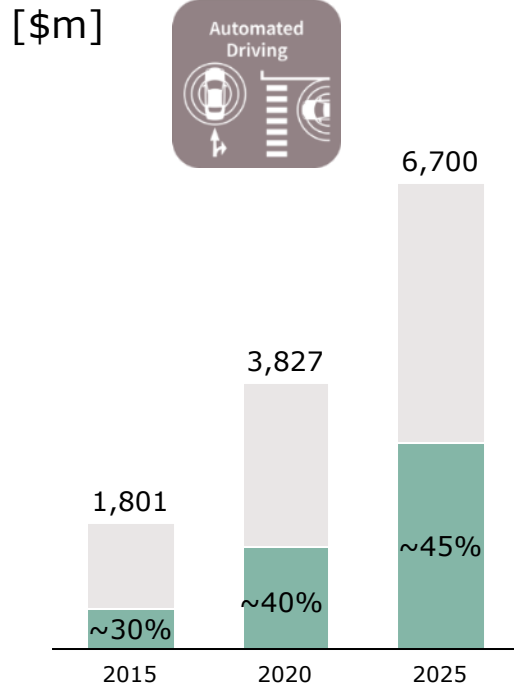

Higher market coverage driven by radar penetration, AURIX™ penetration and actuators

xEV/e-mobility semi market

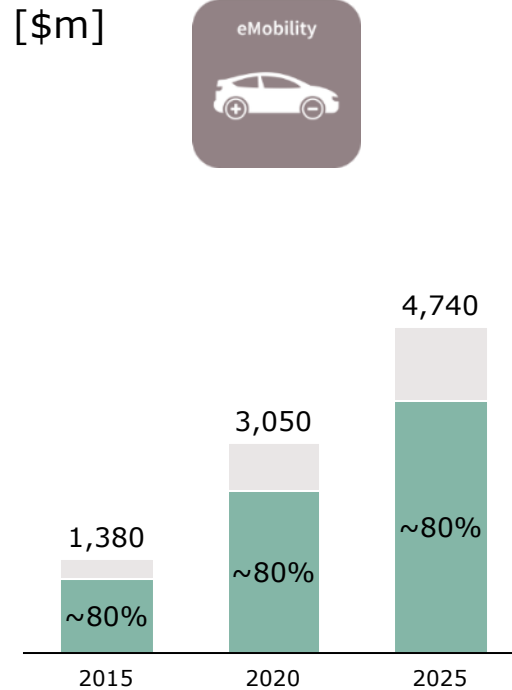

High market coverage already in 2015 will be kept with ramp-up of new power products

Security

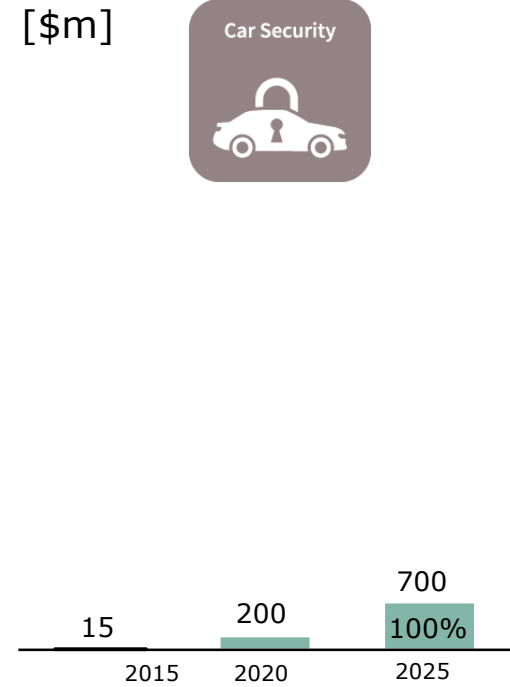

Key enabler for secure connectivity

Source: IHS Markit, Strategy Analytics, Infineon estimations

Addressed by Infineon

Not addressed by Infineon

ADAS, CO₂ reduction and adoption of premium features drive Infineon growth

Vehicle production



- › ~2% growth p.a.
- › Further growth in Western Europe, China, and ASEAN
- › Electro-mobility gaining momentum, especially in China

Drivers for semiconductor content per car

CO₂ reduction



Courtesy: BMW

- › Driven by legislation
- › Improvements of ICE (e.g. electric steering, electric pumps and motors)
- › Adoption of EV/HEV

Advanced safety



Courtesy: Audi

- › Current: crash avoidance
- › Next: assisted driving
- › Future: autonomous driving

Comfort, premium



- › Premium cars are early adopters of high-end comfort and safety features
- › Trickling down to mid-range

~8% p.a. through-cycle growth

Infineon automotive financials at a glance

Revenue and segment result development

[EUR m]

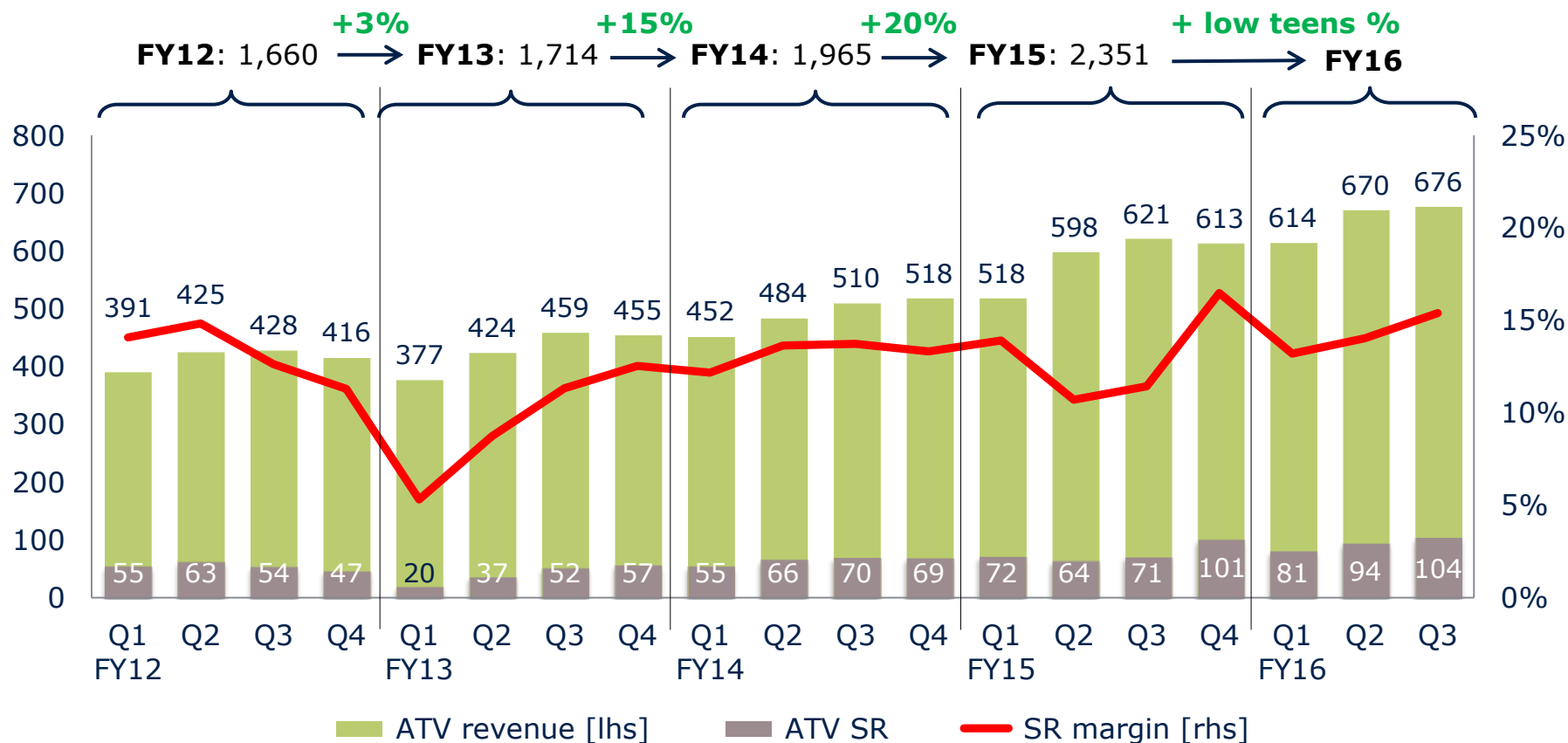

Infineon automotive is excellently positioned in the top growth applications of today



Automotive market

- > 50% of Infineon automotive market growth driven by ADAS/xEV
- > Infineon addresses
 - > up to 80% of xEV BoM and
 - > 40% of ADAS BoM
 - > 100% of security BoM

Infineon automotive

- #2** automotive semiconductor
- #1** power semiconductors
- #2** sensor semiconductors
- #3** microcontrollers

Infineon's value proposition

1. Infineon enables assisted, automated and autonomous driving by a system approach covering sense, compute, and actuate
2. Our products are based on technologies which enhance xEV cost-performance
3. Infineon provides innovative products for a secure car architecture and thus offers an appropriate level of protection





Part of your life. Part of tomorrow.

